



# NISSAN DIESEL AMERICA, INC.

DATE: MAY 30, 2000  
MODEL YEAR: 1999 AND 2000  
MODELS AFFECTED: UD1800CS  
BULLETIN #: SC - 124/125  
FILE AT THE END OF THE ENGINE SECTION OF THE TECHNICAL BULLETIN BINDER

VOLUNTARY SAFETY RECALL CAMPAIGNS #00V-124 AND 00V-125:  
1999 AND 2000 MODEL YEAR UD1800CS MODEL VEHICLES FUEL SUPPLY  
HOSE AND FUEL FILTER SUPPORT BRACKET REPLACEMENT

## MODELS AFFECTED

All 1999 and 2000 model year UD1800CS medium duty vehicles produced between February, 1998 and February, 2000. Each dealer will receive a computer listing of affected vehicle identification numbers either in unsold inventory or retail delivered to customers by the dealer. The applicable vehicles involved in these safety recalls are as follows:

1999 Model Year UD1800CS: JNAMCU2H3XGG50001 ~ JNAMCU2H6XGH50450

2000 Model Year UD1800CS: JNAMCU2H1YGE55001 ~ JNAMCU2HXyah55283

## DESCRIPTION

The possibility exists that the vehicle may have one or both of the following conditions that may result in the fuel hoses contacting the engine assembly and/or brackets during normal vehicle operation:

00V - 124: The diesel engine fuel supply hose from the fuel filter to the top of the fuel injection pump is routed in a manner that may allow the hose to come in contact with the engine block.

00V - 125: The fuel filter support bracket may crack and break due to vibration, which could allow the fuel filter to separate and lodge on top of the chassis frame and come in contact with the engine assembly.

The repairs to correct these conditions consist of the following:

00V - 124: Replacement of the existing diesel engine fuel supply hose with a redesigned fuel hose that has a different shape from the existing fuel hose. Due to the design change and routing of the redesigned fuel hose, the engine electrical harness connector bracket and the FICD valve bracket will also require replacement with redesigned brackets.

00V - 125: Replacement of the existing fuel filter support bracket with a new bracket redesigned to prevent cracking and breaking during normal vehicle operation.

All owners of the affected vehicles will be notified by mail and instructed to make an appointment with an authorized UD Truck Dealer to have these Safety Recalls performed. These repairs will be made free of charge to the UD Truck Customer.

The National Highway Traffic Safety Administration has assigned the identification number 00V-124 and 00V-125 to these Safety Recalls. These numbers must appear on all communications and documentation of any nature related to the campaign described in this bulletin.

ADMINISTRATION / DEALER RESPONSIBILITY

Proceed immediately to make the necessary repairs to the affected vehicles in unsold dealer inventory. All new and used inventory vehicles subject to this recall must be corrected prior to sale, transfer or delivery. Each dealer will receive a computer listing of all affected vehicle identification numbers in either unsold inventory or retail delivered to customers. With this computer listing, the dealer will receive an "Authorization For Recall Notification Service" card for all unsold or undelivered inventory vehicles. This postage prepaid card must be filled out correctly and returned to the address on the card indicating whether the vehicle was repaired, transferred, sold, etc. (refer to the UD Warranty Policies & Procedures Manual, Part III, Section 1). For vehicles without an "Authorization For Recall Notification Service" card, check the vehicle identification number with the Vehicle Service Notification screen of the NDANET2 Warranty Claim System menu to verify that it requires the safety recalls.

PARTS INFORMATION

The parts required to complete the repairs as described in this Safety Recall are available immediately for UD Dealers to order through the NDA Parts Operations Department. Use the attached computer list to order the proper number of parts to repair the listed vehicles. The dealer should note that the part numbers in the list below are grouped by the applicable step number of the instructions. The part numbers for Steps "D" and "E" apply only to vehicles equipped with air conditioning and should only be ordered if they are required.

<b>PART NUMBER</b>	<b>DESCRIPTION</b>	<b>QTY.</b>	<b>STEP</b>
16419 - 30Z67	BRACKET, FUEL FILTER	1	A
17550 - 30D00	FUEL HOSE	1	B
17551 - 30D01	FUEL HOSE	1	B
16635 - 97013	FUEL HOSE GASKET	8	B
24220 - 30D00	BRACKET, HARNESS CONNECTOR	1	C
24210 - T8000	CLAMP, FICD HARNESS (FOR VEHICLES WITH A/C)	1	D
01935 - 12074	BRACKET, FICD HARNESS (FOR VEHICLES WITH A/C)	1	E

NOTE: Approximately 60% of all involved vehicles are equipped with air conditioning.

## SERVICE INFORMATION

Some vehicles may have been previously repaired at a port facility, indicated by the installation of the improved fuel filter support bracket shown below.

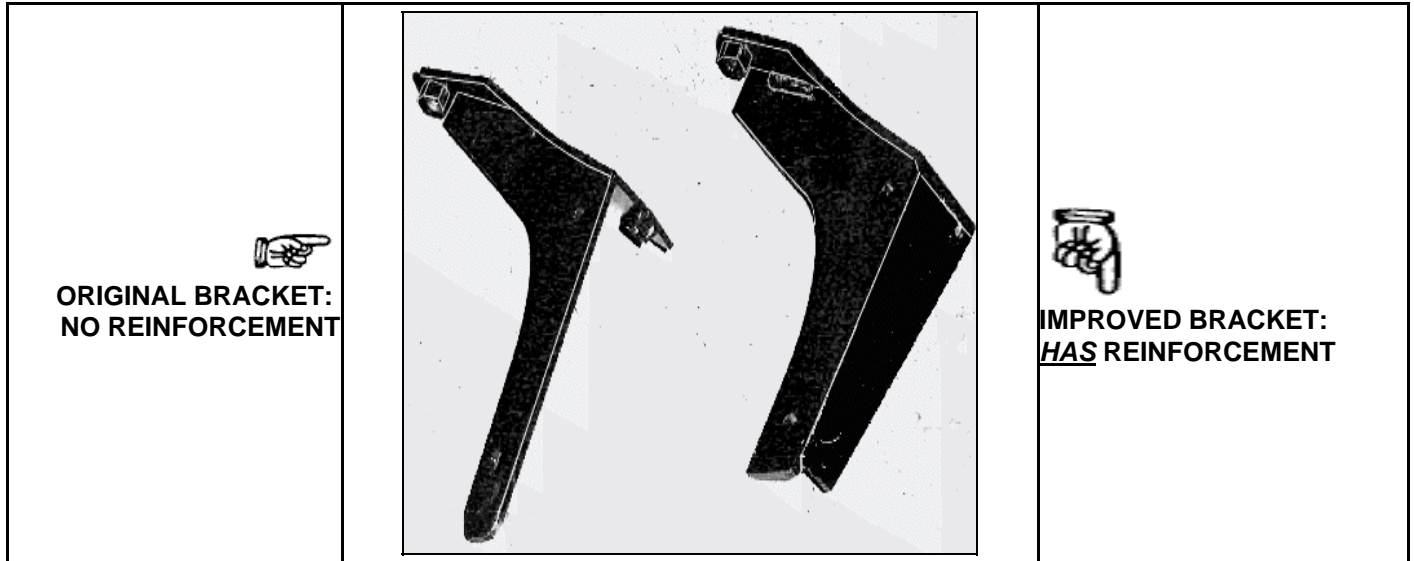

- If the involved vehicle has the improved fuel filter support bracket, indicated by additional reinforcement, both safety recall campaigns have already been performed and no further action is necessary. Proceed directly to the [WARRANTY INFORMATION](#) section for warranty claim reimbursement instructions.

- If the involved vehicle *does not* have the improved fuel filter support bracket, complete both safety recall campaigns according to the following instructions.

Recall Bulletin SC-124/125 is a multi-step procedure in which all steps must be completed during the same service appointment. Before servicing the vehicle, ***read the entire set of instructions first.*** Observe the following safety precautions to prevent personal injury, damage to property, or both:

- Park the vehicle on a flat surface, place the transmission in NEUTRAL (or PARK for automatic transmissions), set the parking brake and chock the wheels.

- Turn the engine off and allow it to cool before servicing.

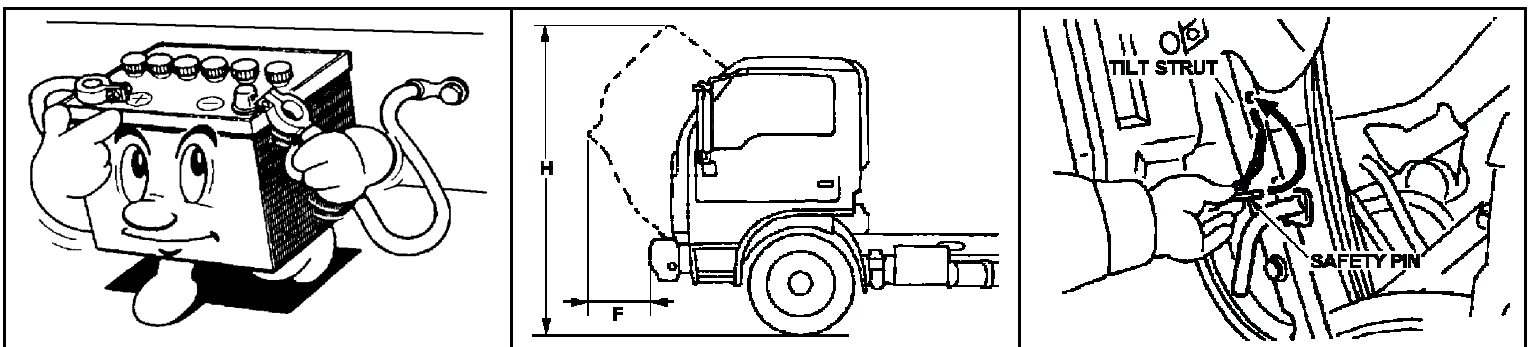

- Disconnect the battery negative (-) cable.
- Tilt the cab using the assist handle. When tilting the cab indoors, ensure there is sufficient cab height (H) and forward (F) clearance as shown above.
- Insert the safety pin into the designated hole of the tilt strut as shown above.
- Observe applicable safety precautions for the handling and disposal of spilled diesel fuel.

A. RECALL 00V-125: REPLACE THE FUEL FILTER SUPPORT BRACKET

1. Using a 12 mm wrench, remove the fuel hose clamp mounting bolt "A", as shown in the illustration on the right. Save the clamp and bolt for later use.
2. Using a 14 mm wrench, remove both fuel filter mounting bolts "B". Save the bolts for later use.
3. Using 17 and 14 mm wrenches, remove the nuts and bolts "C" and "D" (2 ea.) that attaches the existing bracket to the cab latching mechanism. Discard the bracket, but save the nuts and bolts.
4. Install the new fuel filter support bracket in the reverse order of its removal. Tighten nuts and bolts as follows:

**A = 9 ft-lb (13 N-m, 1.3 kgf-m)**

**B = 19 ft-lb (25 N-m, 2.6 kgf-m)**

**C and D = 32 ft-lb (43 N-m, 4.4 kgf-m)**

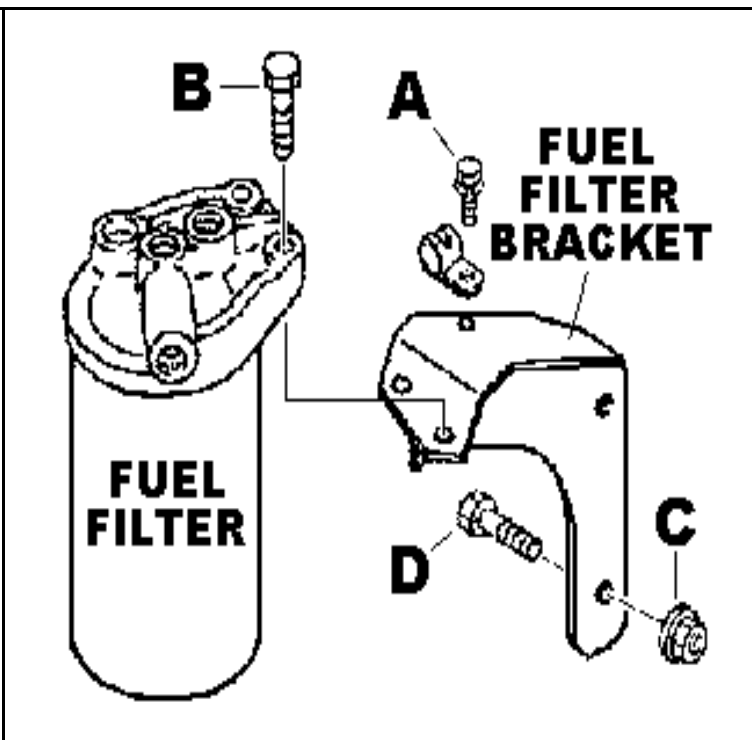

B. RECALL 00V-124: REPLACE TWO FUEL HOSES (AND ALL OTHER FOLLOWING STEPS)

1. Install new bolts, nuts and flat washers in the rear mounting location as shown below. Using a 19 mm socket and torque wrench, tighten the bolts to 69 ft-lb (93 N-m) torque.

**REMOVE AND DISCARD THIS PLASTIC TIE AND THIS HOSE CLIP**

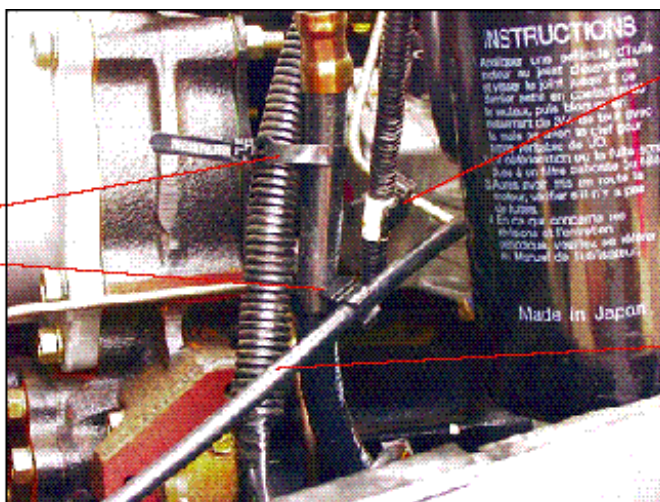

**RETAIN THIS CLIP, DO NOT REMOVE IT**

**ACCELERATOR CABLE**

2. Using a 19 mm wrench, remove the eyebolts from the two fuel hoses as shown in the drawing on the right. Save the eyebolts for later use, but discard the hose gaskets.

NOTE: Do not mix up the eyebolt positions.

The eyebolts are *NOT INTERCHANGEABLE*, as shown below. If the eyebolt positions are mixed up, a fuel restriction will occur.

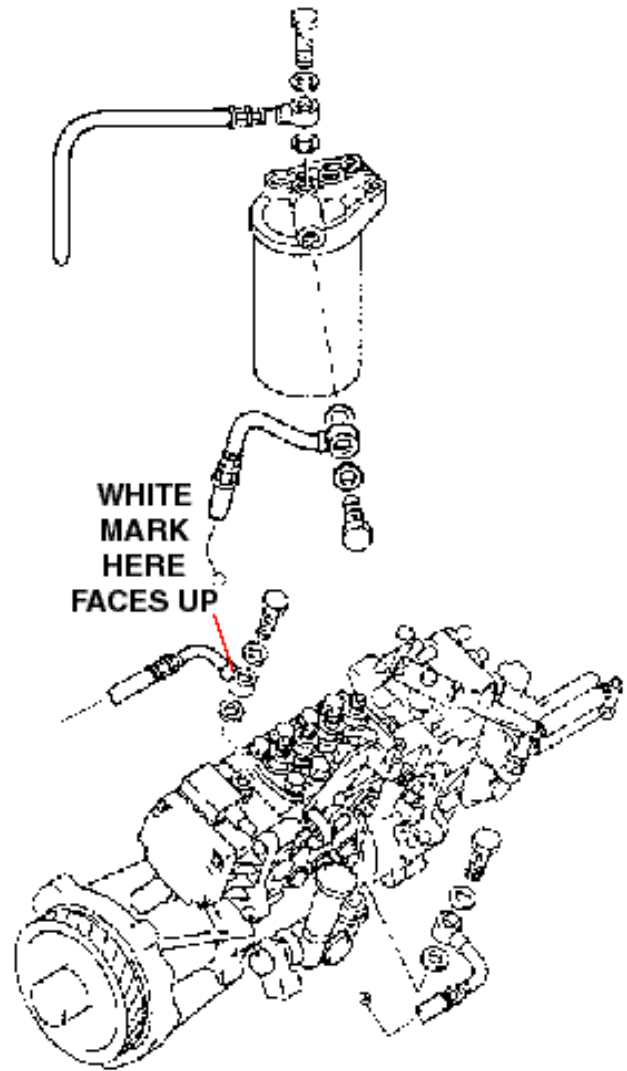
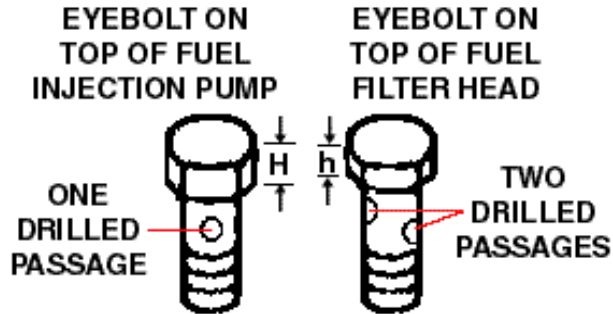

3. Discard the existing fuel hoses. Clean the eyebolts in preparation for installing the new fuel hoses with new gaskets.

4. Using new gaskets with the eyebolts, loosely install both new fuel hoses.

a. Install fuel hose 17551-30D01 (top of injection pump to top of fuel filter) with the white mark on the injection pump fitting facing up as shown below.

b. Index the injection pump fitting perpendicular (90°) to the injection pump centerline as shown below.

c. Index the fuel filter fitting on the centerline of the fuel filter head as shown below.

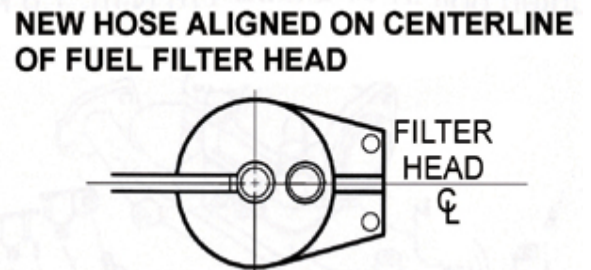
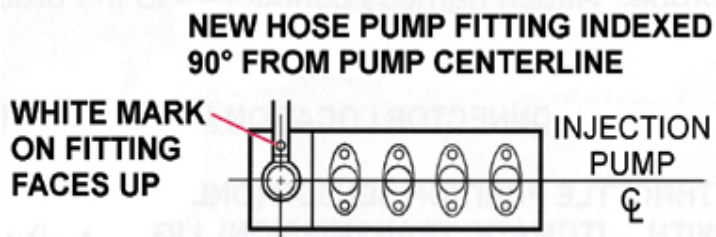

d. Fuel hose 17550-30D00 (fuel transfer pump to fuel filter) may or may not have indexing tabs on the fittings, as shown below. The tabs are no longer part of the manufacturing process, and they are not required to make a proper hose installation. Either hose may be used.





5. Tighten eyebolts to 18.5 ~ 21.4 ft-lb (25 ~ 29 N·m, 2.5 ~ 2.9 kgf·m) torque while holding the fuel hose fittings in their positions described above.

6. Maintain at least 5mm of clearance between the new fuel hose and intake manifold as shown. Maintain at least 10mm of clearance between the new fuel hose and timing gear cover as shown.

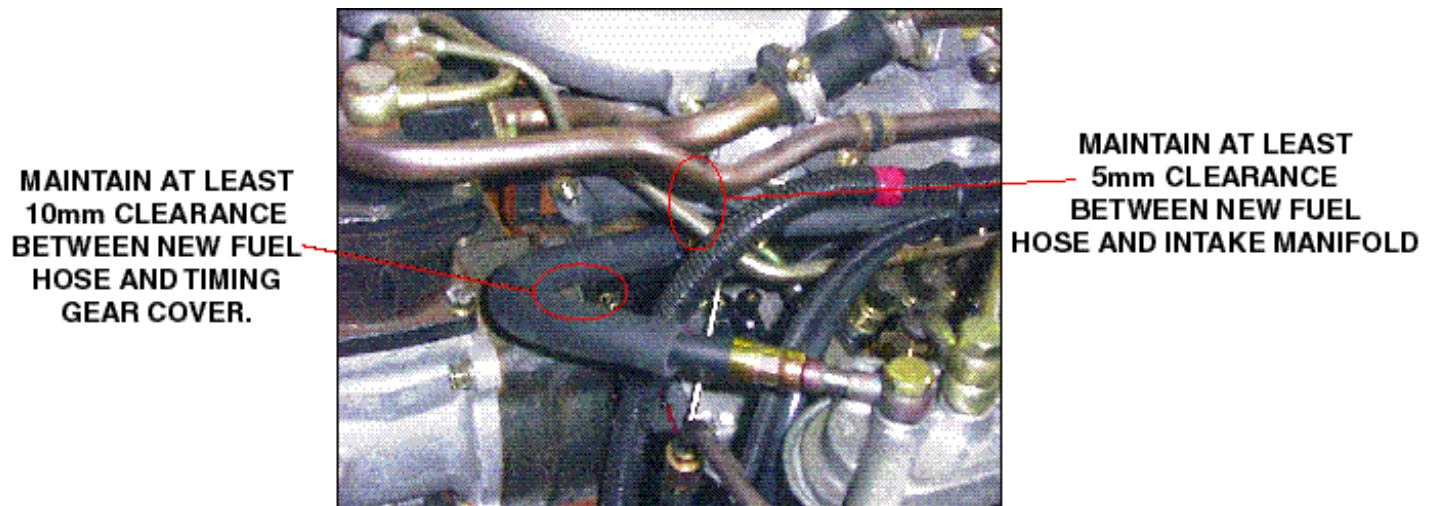

7. If hose clearance is insufficient, loosen the eyebolts and adjust the hose as necessary. Tighten the eyebolts to the proper torque.

C. REPLACE THE ENGINE WIRING HARNESS CONNECTOR MOUNTING BRACKET

1. Remove the harness connectors from the bracket. Using a 12 mm wrench, remove the existing harness connector mounting bracket from the back of the intake manifold as shown. Save the bolt for later use but discard the mounting bracket.

2. Attach the new bracket to the intake manifold with the bolt removed from the previous step. Tighten bolt to 11.8 ft-lbs (16 N·m, 1.6 kgf·m) torque. Attach harness connectors to the bracket.

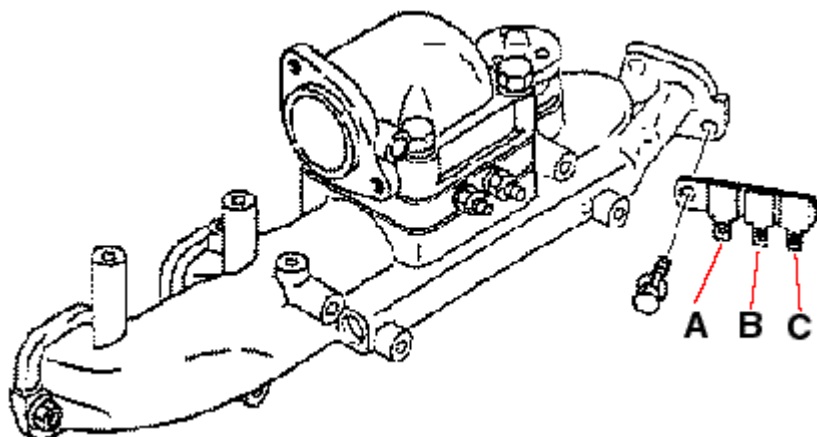

HARNESS CONNECTOR LOCATION AND DESCRIPTION

A = THROTTLE POSITION SENSOR (ONLY FOR VEHICLES WITH AUTOMATIC TRANSMISSION), LIGHT GRAY COLOR

B = MD-TICS PRE-STROKE SENSOR, DARK GRAY COLOR

C = MD-TICS RACK POSITION SENSOR, BROWN COLOR

3. Adjust harness tie as necessary to provide sufficient slack in wiring harness and approx. 25mm of clearance between the harness and the fuel hose as shown below.

**MAINTAIN APPROX. 25mm CLEARANCE BETWEEN HARNESS AND FUEL HOSE**

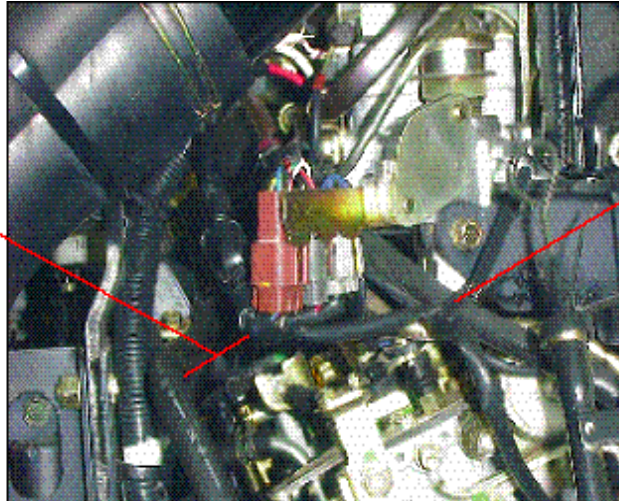

**SECURE THE FICD VACUUM HARNESS, THE COOLANT TEMPERATURE SENSOR WIRE AND THE TURBO BOOST HOSE TOGETHER WITH THE EXISTING HARNESS TIE**



For vehicles **without** air conditioning, proceed directly to Step [F. Check Modifications.](#)



For vehicles **with** air conditioning, continue with the following instructions.

#### D. INSTALLATION OF FICD VACUUM HARNESS CLAMP

1. Install the new FICD vacuum harness clamp on the air compressor nut and bolt, as shown below, with the clamp arms facing forward.

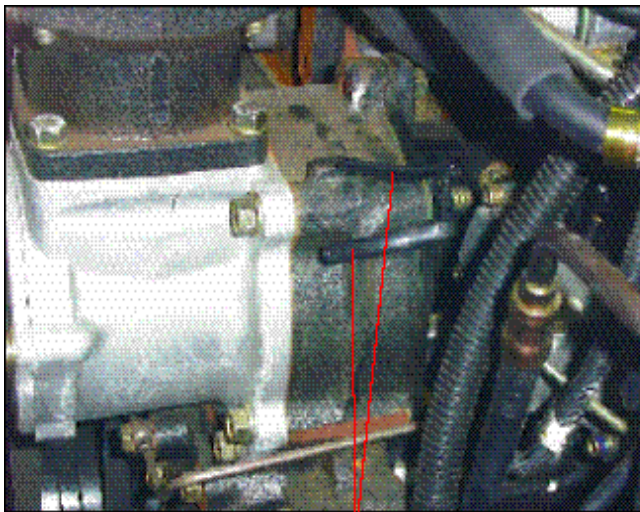

**INSTALL NEW FICD VACUUM HARNESS CLAMP ON AIR COMPRESSOR NUT AND BOLT WITH THE CLAMP ARMS FACING FORWARD**

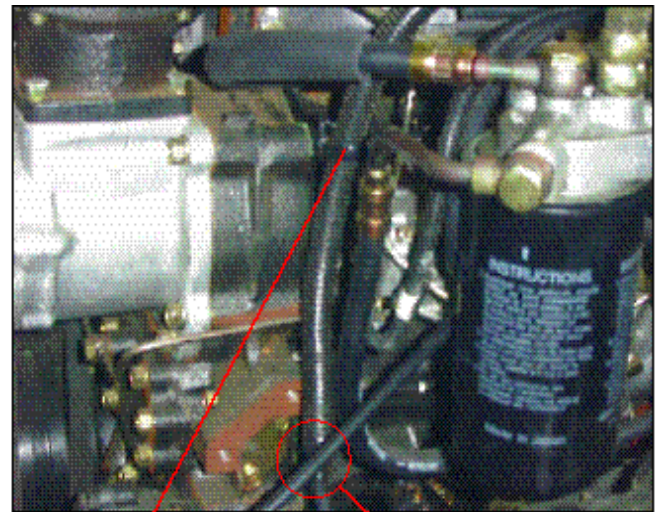

**BEND CLAMP ARMS AROUND THE FICD VACUUM HARNESS ...**

**... TO HOLD IT AWAY FROM THE ACCELERATOR CABLE**

2. Bend the clamp arms around the FICD vacuum harness to hold it away from accelerator cable and the fuel hose. Adjust the vacuum harness as necessary to provide sufficient slack.



## E. REPLACEMENT OF FICD VALVE HARNESS MOUNTING BRACKET

1. Using a 12 mm wrench, remove the bolt that attaches the wiring harness clamp to the bracket. Remove the clamp from the harness. Save the clamp and bolt for later use.
2. Remove the bracket mounting nut and bolt. Discard the bracket but save the nut and bolt for later use.

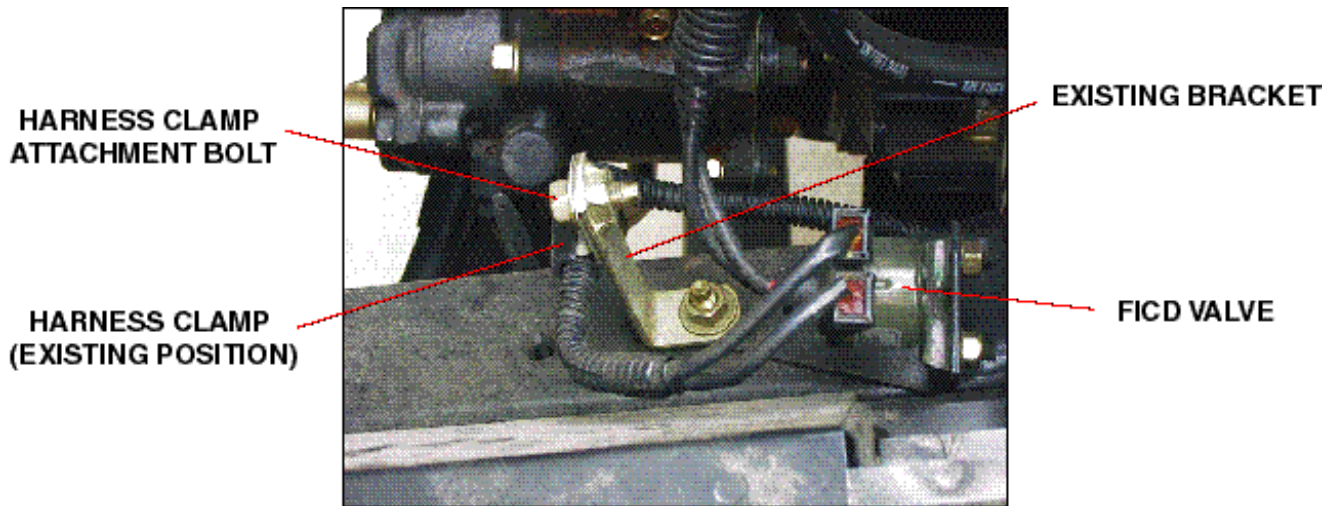

3. Install the new FICD harness mounting bracket in reverse order of its removal. Remove and reverse the position of the harness clamp so that it mounts above the attachment bolt as shown below. Torque fasteners to 9 ft-lbs (13 N-m, 1.3 kgf-m).

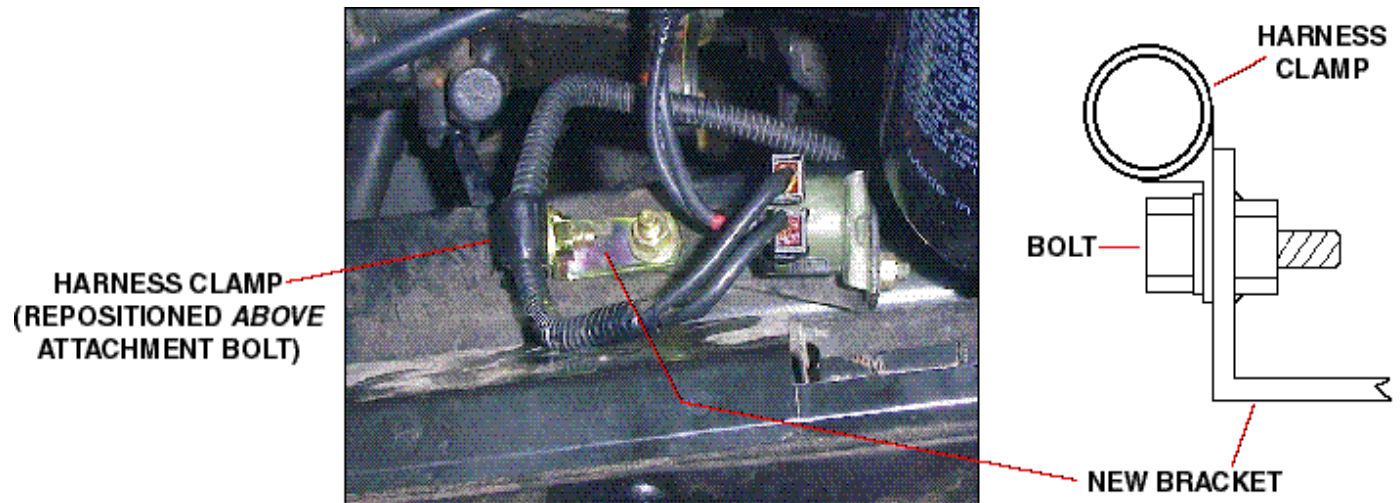

## F. CHECK MODIFICATIONS

- Reconnect the battery negative (-) cable.
- Clean spilled diesel fuel from around the fuel injection pump and fuel filter.
- Start the engine to check for fuel leaks and repair as necessary.



WARRANTY INFORMATION

Expenses for the repairs described in this Recall Bulletin are to be recovered through the standard UD Warranty Claim Procedures as listed in the UD Warranty Policies & Procedures Manual, PART III and PART V. Please mail the "Authorization for Recall Notification Service" card to Nissan Diesel America, Inc. when the warranty claim is submitted. Use the following special information to prepare your warranty claims:

WARRANTY CODE:	K539 *	
REPAIR DESCRIPTION:	PERFORM SAFETY RECALLS # 00V - 124 AND 00V - 125	
LABOR OP. NUMBER:	117X	
LABOR TIME ALLOWED: (CHOOSE APPLICABLE TIME FOR REPAIRS PERFORMED)	INSPECTION ONLY	0.2 HRS
	INSPECTION AND CORRECTION	1.0 HRS

\*NOTE: When the Warranty Code is entered, the NDANET2 Warranty Claim system will automatically enter the Warranty Trouble Code and the Failed Part Number into the claim.