



CSR Report 2017

UD Trucks Corporation

CSR Report 2017

Editorial policy

UD Trucks publishes its CSR reports for our stakeholders, describing our approaches and practices of the company's corporate social responsibilities as our contributions towards a sustainable society. This 2017 issue includes feature pages, casting a light on the all-new Quon truck and the Traffic Safety Seminar for Elementary School Students. The articles in the Report section present the various activities arranged by the five prioritized themes at UD Trucks.

Scope of report content

This publication is prepared to report on UD Trucks Corporation, but it also encompasses certain activities conducted by the Volvo Group for UD Trucks as one of its business areas.

Coverage period

Fiscal year (FY) 2016 (from January 1 to December 31 of 2016), and it also partially contains contextual information and data from previous periods, as well as reports on some activities conducted in FY 2017 and future action plans.

Published in November 2017

Contents

Message from the Top	02
About UD Trucks Corporation	03
CSR at UD Trucks	05

Feature 1	07
-----------	----

Our Contribution to the Logistics Industry

Launch of the All-New Quon



Feature 2	11
-----------	----

Our Contribution to Communities

Offering Traffic Safety Seminars for Elementary School Students



CSR activity report	(1) Improving Customer Satisfaction	15
	(2) Better Collaborative Relationships with Business Partners	20
	(3) Allowing Employees to Perform to Their Full Potential	21
	(4) As a Member of Society	23
	(5) Our Environmental Management	25
	Environmental Data	29
The Volvo Group		33

As we work towards the vision of “providing the trucks the world needs today,” we pursue solutions to our stakeholders’ challenges.

A company’s social mission is to continue growing with its customers and other diverse stakeholders, thereby investing the profits it has earned in new business activities and making contributions to local communities to share enriching experiences with as many people as possible.

To fulfill this mission, UD Trucks has maintained its vision of “providing the trucks the world needs today” since its foundation in 1935. Paying close attention to feedback from our customers at all times, we have pursued our goal to provide new products, services, and solutions to help our stakeholders meet their business challenges.

Moreover, given the impact that our activities may have on society, we also believe that it is vital to contribute to the development of sustainable society as we pursue our business growth by putting more effort into our compliance, risk management, corporate governance, and environmental action plan.

The all-new heavy-duty Quon truck launched in 2017 symbolizes these approaches we maintain. The all-new Quon is made with state-of-the-art technology to provide solutions to our customers’ business challenges, such as meeting standards for safety, environmental performance, and productivity. That is, Quon is a product of UD Truck’s innovative efforts toward sustainable transport solutions.

While offering innovative trucks such as Quon across the globe, we also wish to remain a community-based organization. We hold traffic safety seminars for children and offer an internet training course for elderly people in the local communities where our business offices are located.

Our environmental action plan has also been making further progress. FY2015 was the year that manufacturers were urged to meet their targets specified by the current heavy-duty vehicle fuel efficiency standards. The results that UD Trucks achieved during that year were acknowledged, and in 2016, we were rated as a manufacturer that had successfully achieved the goals.

In 2015, the United Nations adopted the Sustainable Development Goals (SDGs), which emphasizes the importance of innovation and partnerships with stakeholders as part of the efforts to achieve the seventeen Goals to Transform Our World. In the same year, the United Nations Climate Change Conference (COP 21) adopted the Paris Agreement as a new international framework.

With these international environmental needs in mind, UD Trucks will work on the next innovation to become a good partner of our stakeholders in Japan and overseas. We will combine the Volvo Group’s advanced technologies with UD Trucks’ experience, sophisticated engineering skills, and Gemba spirit, thereby meeting challenges as “One UD” to achieve the full potential of our organization that boasts the power of integrated manufacturing and marketing.

村上吉弘

Yoshihiro Murakami
President and Representative Director
UD Trucks Corporation



Going the Extra Mile

UD Trucks Corporation has more than 80 years of history as a commercial vehicles manufacturer. We have our vision of “providing the trucks the world needs today” since the foundation, and our business activities continue to revolve around it.

As a company in the logistics business that forms part of social infrastructure, we constantly pay close attention to the needs of society and feedback from people engaged in the logistics industry and make extra efforts to offer products and services as well as an unsurpassed level of excellence for our customers. Today, UD Trucks engages in the manufacture and sales of vehicles of the UD Trucks brand. As a member of the Volvo Group, we also represent the Volvo and Volvo Penta brands, acting as their Japan base.





The history of UD Trucks

- | | |
|---|--|
| 1935 Establishes Nihon Diesel Industries, Ltd. in Saitama, Japan, aiming at producing diesel engines | 1990 The launch of the Big Thumb with improved low emissions, comfort, and safety |
| 1938 Completion of the first diesel engine | 1996 Establishes Hangzhou Dong Feng Nissan Diesel Motor Co., Ltd. in a joint venture in China |
| 1939 Completion of the first diesel truck, which undertook a total of 3,000 km legendary test run | 2004 Birth of Quon, UD Trucks' flagship heavy-duty truck |
| 1942 The company is renamed Kanega-Fuchi Diesel Co., Ltd. | 2006 AB Volvo becomes a major shareholder in the Company |
| 1946 The company is renamed Minsei Sangyo Co., Ltd. | 2010 The company name is changed to UD Trucks Corporation |
| 1950 The company is renamed Minsei Diesel Industries, Ltd. | 2013 Birth of Quester, a brand new heavy-duty truck developed for global growth markets |
| 1955 Birth of the original UD engines | 2014 Merger with a sales company UD Trucks Japan Corporation
The launch of light-duty truck Kazet |
| 1958 The launch of Japan's first truck with an over 10-ton payload, 6TW, leveraged in the construction of the Shinkansen network | 2015 Celebration of the company's 80th anniversary |
| 1960 The Company is renamed Nissan Diesel Motor Co., Ltd. | 2017 Birth of the all-new Quon
The launch of the medium-duty truck Croner and light-duty truck Kuzer for global growth markets |
| 1962 Ageo plant commences its operation | |
| 1975 The launch of the medium-duty truck Condor | |



Company profile (as of January 1, 2017, except for the number of employees)

Company name	UD Trucks Corporation
Date of foundation	December 1, 1935
Head office	1-1, Ageo-shi, Saitama 362-8523, Japan
Capital	77.5 billion yen
Number of employees	6,307 including contract and temporary employees (as of the end of December 2016)
Main business	Development, manufacture, and sales of UD Trucks brand's heavy- and medium-duty trucks, as well as the sales of UD Trucks brand's light-duty trucks; manufacture and sales of diesel engines; manufacture and sales of vehicle components; maintenance of trucks and buses and sales of service parts; as well as import and sales of Volvo and Volvo Penta brand's products
Domestic group companies	VFS Japan Co., Ltd., New-Mech Co., Ltd., Volvo Technology Japan Corporation

Officers	Executive Chairman and Representative Director Joachim Rosenberg	President and Representative Director Yoshihiro Murakami
		
	Director (part-time) Kerstin Renard	Auditor Noriaki Fujii
		

Production sites and facilities

We have a service network of 166 locations across Japan to offer support for our customers' business.

○ The numbers of UD Trucks' dealers in the regions (including private dealers)

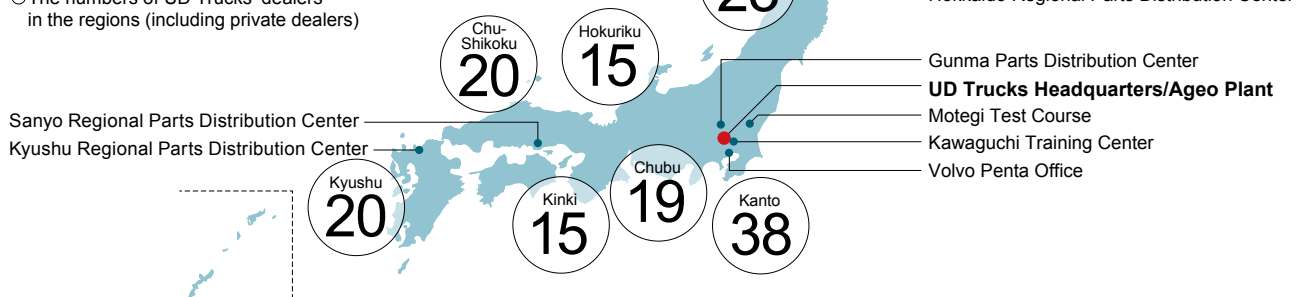

Sales of UD Trucks Brand's Vehicles (thousands of vehicles)

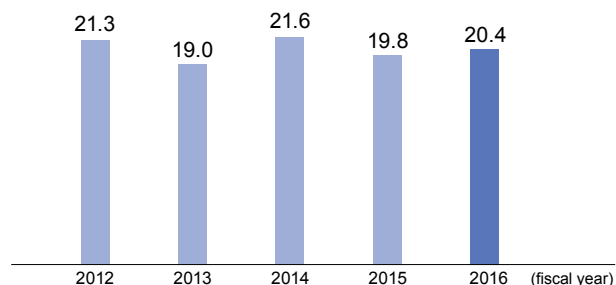

Sales of UD Trucks Brand's Vehicles by Market (the numbers of vehicles shipped from plants in FY2016)

Latin America	386
Asia	16,772
Japan	10,661
Southeast Asia	4,211
South Asia	910
Middle East	990
Oceania	1,030
Africa	2,231
Total	20,419

The brands and products sold by UD Trucks Corporation



UD Trucks

UD Trucks brand's heavy-duty truck Quon, medium-duty truck Condor, light-duty truck Kazet, and dedicated models Quester, Croner and Kuzer for the growth markets.



Volvo Trucks

Import and sales of Volvo brand's heavy-duty trucks. Main products in Japan include Volvo FH 4x2 and 6x4 tractors.



Volvo Penta

Import and sales of Volvo Penta brand's marine and industrial engines. Main products in Japan include inboards, IPS marine engines and generator engines.



Volvo Construction Equipment

Import and sales of Volvo brand's construction equipment. Main products in Japan include wheel loaders and articulated dump trucks.

We pursue activities designed to create shared value consistent with the Volvo Group’s approaches.

Basic approaches to CSR

The Volvo Group’s mission is “driving prosperity through transport solutions.” To facilitate the pursuit of its CSR activities, the Group revised the “CSR and sustainability approach,” which serve as the framework of Volvo’s CSR activities in 2016. In the updated framework designed for “driving prosperity” is underpinned by three pillars: our value chain activities, towards sustainable transport, and our role in society. The Volvo Group aims to help develop a sustainable society by pursuing these activities.

Furthermore, the Volvo Group gives priority to joining international initiatives and achieving international goals, including the UN Global Compact and Sustainable Development Goals (SDGs) as well

as keeping dialogues going with stakeholders.

The SDGs were adopted by the UN General Assembly in 2015. Of the seventeen goals that must be achieved, the Volvo Group is emphasizing the following four “3. Good health and well-being,” “9. Industry, innovation and infrastructure,” “11. Sustainable cities and communities,” and “13. Climate action.”

UD Trucks builds its operation upon these approaches taken by the Volvo Group while maintaining its business strategy and brand personality. We make good use of our expertise, talent, facilities, and other managerial resources to fulfill our commitment to creating value for our stakeholders and UD Trucks.

CSR and sustainability approach

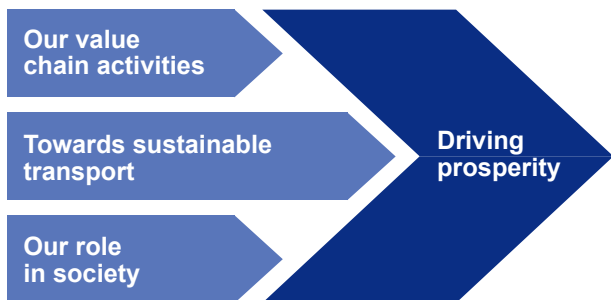

Priority SDGs



Code of Conduct

The Volvo Group Code of Conduct specifies basic principles and behavior required to fulfill the Group’s CSR including “compliance,” “customer satisfaction,” “supply chain management,” and “human rights and labor practices.” All employees must follow the code. In 2016 the Group developed and rolled out a new e-learning program to ensure that the Code of Conduct is understood and practiced across the Group.



The Volvo Group Code of Conduct (left) e-learning program screen (right)



CSR management system

There are dedicated CSR/environmental management team under the Public Affairs Department that is responsible for negotiations with national/regional governments and industrial authorities. They also engage in collecting information about the CSR-related activities that are conducted by each division, as well as planning and managing various company-wide initiatives.

In order to ensure the company-wide alignment, each division appoints its dedicated CSR staff, who meet regularly to share information cross-functionally and plan and discuss specific activities. They also report the progress in these activities to the top management board, and receive their instructions, decision-making and approval.

UD Trucks' CSR management system

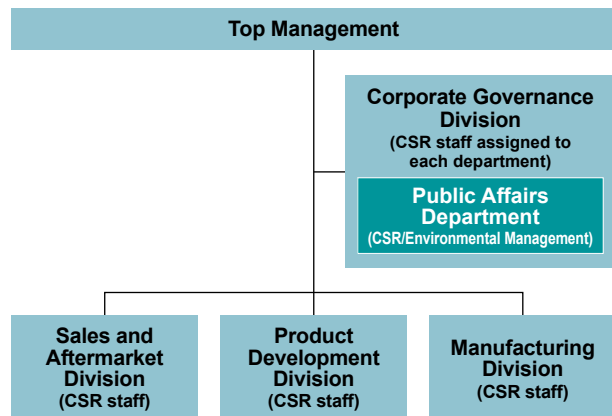

Compliance

We strive to conduct our business in compliance with such principles as prevention of misconduct and promotion of fair competition, appropriate taxation, and no-conflict-of-interest policies as stipulated in the Volvo Group Code of Conduct. Regular educational programs on compliance are provided for employees (including management) as group training, e-learning, or in any

other appropriate forms to familiarize them with the laws and regulations such as the competition law and anti-bribery law, as well as the Volvo Group corporate rules. We also implement whistleblower and auditing systems to allow suspected cases of non-compliance to be reported for appropriate corrective actions.

Risk management

The risk management committee has been installed to bolster the operation of the risk management system. UD Trucks identifies that major natural disasters, fire, infection, information leakage, and administrative risks such as involving personnel/labor management are the risks that need to be addressed. Major earthquakes and fire are deemed particularly significant as they may

jeopardize business continuity, and thus we upgrade our fire prevention systems based on the regular risk audit reports, conduct periodical drills with an emergency response unit, and review our emergency plans. We also prepared the risk management and business continuity plans in accordance with the Volvo Group's Security Policy.

Information security

We ensure information security by following the Volvo Group's Security Policy. As part of our efforts, we are developing information security governance that incorporates the policy.

To be more specific, we manage and operate electronic information at two places, namely our headquarters and highly earthquake-resistant data center, to prevent our systems from ceasing to work due

to a disaster. We also have enhanced countermeasures against electronic information leakage due to attacks from outside. Moreover, we hold regular educational programs for reinforced information security for our dealers across Japan.

In addition to these actions, UD Trucks follows the Volvo Group's Privacy Policy to ensure proper management and protection of personal information.



Feature 1
Our Contribution to the Logistics Industry

Launch of the All-New Quon



Sustainable truck transport requires **care for environment, safety and drivers**



Of all domestically transported goods, freight transported by truck makes up about 90 percent when measured in tons, and about 50 percent in ton-kilometers. The logistics industry is committed to meeting increasingly tough environmental regulations, enhance safety measures, and improve truck drivers' work environments in order to fulfill its mission to provide infrastructure critical to Japanese society and its economy.

Comparison of regulatory limits of heavy-duty diesel vehicles' exhaust gas emissions

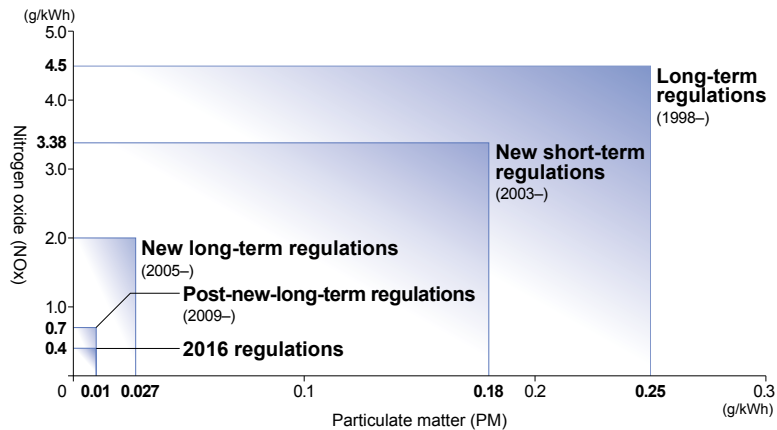

Source: 2017 Understanding Automobiles by Looking at Numbers, Automobile Business Association of Japan, the Road Transport Bureau of the Ministry of Land, Infrastructure, Transport, and Tourism

Quon is a new solution to the logistics industry's challenges.



The concept is "Innovation that puts people first."

In April 2017, UD Trucks launched the all-new heavy-duty Quon truck. We applied UD Trucks' own innovations to the development of the all-new Quon not just to meet the latest emission standards, but to offer a solution to diverse challenges that the logistics industry faces.

By "UD Trucks' own innovations," we mean more than a technological novelty. As a manufacturer of production goods that forms a part of logistics, we strive to propose products and services that create new universal value for customers, society, and the environment. UD Trucks' history is synonymous with the history of the company's efforts toward the evolution of safe, efficient, green, and sustainable transport solutions. It is represented by the inter-vehicle distance warning system (Traffic Eye) we adopted before most competitors across the world; the electronically controlled transmission "ESCOT" that is highly operable and fuel-efficient; and the flagship heavy-duty Quon truck equipped with the world's first urea SCR system.

Truck with advanced solutions across five essential feature areas

A transport solution must offer five essential features: drivability, fuel efficiency and environmental performance, safety, productivity, and uptime. The all-new Quon has significantly advanced versions of these elements.

The cockpit is designed to offer comfortable space to help the driver focus on driving, and the electronically controlled automatic transmission provides superior operability. The fuel efficiency accompanied by environmental performance is highest of all vehicles in the same class, while the vehicle maintains power. The advanced safety features not just protect the driver, passenger, and freight, but ensure safety in the vehicle's surroundings. Improved ease of loading and bodybuilding efficiency coupled with lighter weight enhance productivity. And our wide-ranging after-sales service helps boost uptime.

1 Easier to see, easier to use Drivability



The cockpit has been completely redesigned for driver comfort, with operability and visibility ergonomically re-engineered from the ground up. The ESCOT-VI electronically controlled automatic transmission adopts a straight shift pattern, further advancing the Quon's operability; the disc brakes provide an outstanding braking performance. Through these features, the all-new Quon provides a comfortable driving environment allowing drivers to concentrate on the road ahead.

2 Cleaner and more powerful Fuel efficiency and environment care



The fuel-efficient, powerful, and clean 11-liter GH11 engine complies with Japanese 2016 exhaust gas regulations, and all models achieve +5% over the 2015 fuel economy standards for heavy vehicles in Japan. The engine generates powerful torque from low revs up through a wide RPM range, making the Quon a pleasure to drive. To further support fuel-efficient driving, the Quon also features anticipatory solutions that use GPS to look ahead as well as a system that displays driving advice to help drivers achieve further improvement in fuel economy.

3 Safer and more reliable Safety



The all-new Quon, among others, features the UD Trucks Traffic Eye Brake system (collision mitigation braking), which uses high-precision radar and a cabin-mounted camera for dual-monitoring of the road ahead, as well as advanced driver assistance systems including Driver Alert Support. Our new flagship is also fitted with disc brakes featuring excellent heat-release properties for superb and industry benchmark anti-fade performance.

Customers' challenges

- Transport efficiency and productivity need improvement.
- Truck drivers are in short supply.
- Work environments need improvement.

Global environmental challenges

- Exhaust gas emissions must be reduced (PM, NOx, CO₂).
- Noise must be controlled.

All-new Quon's five advanced features

Mobility society's challenges

- Advanced safety measures are needed.
- Traffic congestion must be reduced.

4 Improved productivity, greater functionality Productivity

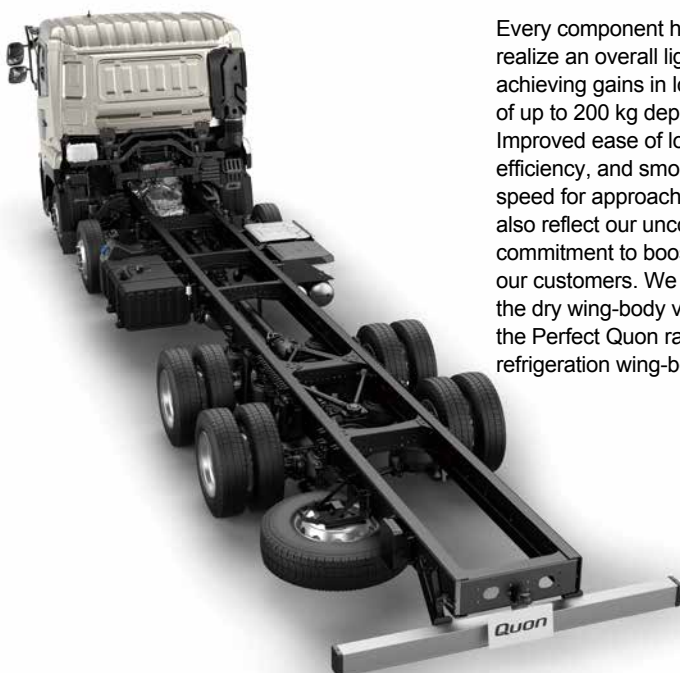

Every component has been refined to realize an overall lighter vehicle while achieving gains in load-carrying capacity of up to 200 kg depending on the model. Improved ease of loading, bodybuilding efficiency, and smoothness at creeping speed for approaching loading docks also reflect our uncompromising commitment to boosting productivity for our customers. We have also expanded the dry wing-body variations available in the Perfect Quon range and added a refrigeration wing-body.

5 Extended peace of mind Uptime



The all-new Quon represents a further improvement in vehicle reliability and durability. It is easier to maintain, with a reduced number of parts requiring regular replacement and longer service intervals on genuine parts. Moreover, comprehensive after-sales service that includes maintenance, a service agreement, and the latest telematics services keeps customers' vehicles in the best possible condition to boost uptime to the maximum.



Product Planner:

My purpose is to help customers achieve business success.

Since new exhaust gas regulations were scheduled to be enforced in 2017, we first had to identify how to meet the requirements of the regulations as we planned the all-new Quon. We also had in-depth discussions about what the logistics industry needs, and what unique contributions UD Trucks can make by tapping into the strengths of the Volvo Group that boasts international perspectives and insights. Then we reached the concept “Innovation that puts people first.”

The concept represents our decision to produce a vehicle that entices drivers to hop into the cockpit and makes them happy to drive it, in addition to offering environmental performance, improved productivity, and efficiency. It led to the creation of key features such as the further-evolved ESCOT-VI (automatic transmission), the design of the driver’s seat, and advanced safety features.

We also plan to advance from Japan to international markets. I hope that the all-new Quon will help as many customers as possible to achieve business success around the globe.

Aki Hoizumi (left)
Product offering, UD Trucks Brand, Communication and Product

Product Developer:

Look to the all-new Quon for quality.

We developed the all-new Quon with a greater commitment to quality than ever. We used about 100 test vehicles for driving tests that covered several million kilometers under harsh conditions to make sure that the Quon offers sufficient safety, drivability, and durability.

Some of these tests were conducted in cold climates to see how the vehicle runs on winter roads. We traveled all the way to Sweden in addition to Hokkaido that is our regular test location. We tested startability, exhaust gas after-treatment, starting and braking performance on a slippery road at very low temperatures; simulated the impact of snow and frost; and assessed the new features and newly-developed disc brakes. Based on the results of these, we worked on the development to enable Quon to retain its highest level of performance on compacted snow and frozen road surfaces.

We also conducted crash tests to assess protective performance for the driver and passenger, durability tests on a test bench to measure the vibration durability of the cabin and chassis, and other various tests. Then the R&D team took measures to address the problems found through the testing and conducted another round of tests to make sure the problems were solved. We repeated this cycle over and over before completing the final product. We will continue listening carefully to what our customers have to say in order to keep developing improved products.

Akira Tateoka (right)
Features, Verification & Validation, UD Trucks Technology



Feature 2
Our Contribution to Communities

Offering Traffic Safety Seminars for Elementary School Students



Traffic accidents caused by trucks can be prevented through road safety campaigns



According to the fact sheet published by the World Health Organization (WHO) in May 2017, the world sees 1.25 million road traffic deaths each year. In Japan, fatal road accidents involving commercial trucks are on the decline. The number, however, still exceeds the target set by the Japan Trucking Association, which means that the promotion of road safety remains a major task the country needs to tackle. Although accidents caused by heavy-duty trucks in particular often lead to grave consequences, the opportunities for the public to learn about those accidents are limited in their daily lives.

Numbers of fatal road accidents by commercial trucks

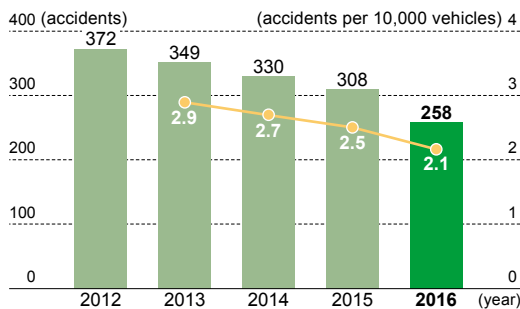

The number of accidents per 10,000 vehicles is 2.1, greater than the target of 2.0*

This chart has been prepared according to statistical data from the Japan Trucking Association. Light-duty vehicles are not included in the commercial trucks in the survey.

* The initial target specified in the 2009 General Safety Plan for Commercial Vehicles.

To reduce road accidents involving trucks to zero, we offer a hands-on educational program on road safety.



The program focuses on leading causes of road accidents and how to behave safely.

Saitama Prefecture has continuously ranked among the worst prefectures for the numbers of fatal road accidents caused by commercial trucks: 1st in 2013, 3rd in 2014, 5th in 2015, and again 1st in 2016*. As a truck manufacturer based in Saitama, UD Trucks hoped to help reduce road accidents. This is how we began to plan the traffic safety seminars for school children.

This initiative aims to help children understand what they should do to stay safe around a heavy-duty truck and other vehicles. It is also linked to the "Stop, Look, Wave" campaign, a road safety program that the Volvo Group has launched across the globe. The hands-on seminar focuses on three points: teaching a truck's blind spots; teaching the difference in circular arcs that front and rear inner wheels follow when a truck makes a turn; and having children think what to do to stay safe by the roadside.

* Source: Statistical data from the Japan Trucking Association. Light-duty vehicles are not included in the commercial trucks in the survey.

The first seminar was held in Ageo where UD Trucks is based.

In June 2016, with help from Ageo City's board of education, we held the first traffic safety seminar for fourth graders of an elementary school in Ageo. Using real trucks, our employees supported the seminar as operation staff and instructors.

Children who participated said, "There were more spots I couldn't see from the driver's seat than I'd thought," and "I'll step further back when I wait for a truck to make a turn at an intersection." In 2016 we held the seminars for about 440 children from four elementary schools. We plan to continue offering the program in 2017 and thereafter.

Traffic Safety Seminar for Elementary School Students

Experience a truck's blind spots

The instructor illustrated a truck's size, blind spots, and differences in circular arcs the inner wheels follow. Then she had one of the children sit in the driver's seat of the real heavy-duty truck and other children stand around the vehicle and asked the one inside the truck who he/she can or cannot see, thereby showing dangerous spots around the vehicle.



Experience the difference in circular arcs that front and rear inner wheels follow

We had the truck run through a mock intersection to demonstrate how a pedestrian can get caught in the wheels as the vehicle makes a left turn, thereby showing how dangerous the difference in circular arcs is. We placed an obstacle acting as a pedestrian waiting for the walk signal in the path of the rear wheels to illustrate the danger more realistically.



Think what to do to stay safe by the roadside

Toward the end of the program, children answered quiz questions about a trucks' blind spots and the difference in circular arcs that front and rear inner wheels follow to refresh their memory, and brainstormed what they should do to stay safe by the roadside. Moreover, all children sat in the heavy-duty truck's driver's seat to experience the real field of vision from there. They left the seminar with a greater awareness of road safety.



Our dealers also offer the traffic safety seminars

Our dealers in Yokohama and the Tohoku region also held the traffic safety seminars for local school children.



Yamagata Customer Center



Yokohama Customer Center

Topic

Internet Training Course for Elderly People

Over recent years, the internet has made a huge amount of day-to-day information available to the public. However, it has also created a situation in which senior citizens unfamiliar with IT tools have limited access to information.

To help make information accessible to people of all generations, UD Trucks and Ageo City's board of education jointly offer an internet training course for local residents aged 60 or older. Some participants have never touched a computer before. We design the program in a way that makes them feel comfortable learning while it is enjoyable and instructive.

Our IT department offered a similar program on its own from 2012 through 2014. In 2016, the course was developed into an activity that involves the whole company. We have been receiving encouraging feedback from the people who took the course, such as "explanations were very clear" and "you provided great support." The course also serves as an opportunity for our employees acting as instructors to improve their communication skills by practicing "giving a clear explanation to people they meet for the first time about what these people learn for the first time." UD Trucks plans to continue offering the course regularly.





We received a variety of feedback from the children's teachers.
(responses to our questionnaires)

Thank-you message from children

“ The lesson was planned from children's perspective. The explanations were clear in a way that helps children remember what they have learned. ”

“ Many of the children say they will practice what they have learned. It was a meaningful seminar. ”

“ The children acquired adequate understanding through the lecture, hands-on experience, and recapitulation. ”

“ As teachers, we were inspired to improve our safety guidance and how we teach it. ”

“ We felt assured that the children were in good hands when we saw many people from UD Trucks interacted with them in a caring manner. ”

“ Since the lesson in this program was hands-on, we believe the children will apply what they learned to their behavior by the roadside. ”

Our Program Operator:

I hope the program will continue to help children —vulnerable road users—to learn about road safety.

As I saw the children seriously working on the lesson, I was sure they understood a heavy-duty truck's blind spots and the difference in circular arcs that front and rear inner wheels follow. At UD Trucks, I develop safe driving support systems for trucks to help drivers drive safely. I believe that the number of road accidents can be reduced when all road users have due regard for the safety of other users. The traffic safety seminar is an opportunity for me to help children who are vulnerable road users learn about road safety, and I find the work rewarding. I'd be happy if I could contribute to a reduced number of road accidents through running the seminar.



Yuichi Hirota Vehicle Electronics & Systems Engineering, UD Trucks Technology

Improving Customer Satisfaction



For the continuous improvement of customer satisfaction, UD Trucks strives to capture the latent needs of customers and the society, reflect them in our products and services, and share beneficial information through various events and communication activities.

Basic approach to our customers

Offering products and services that respond to the needs of customers and the society

At UD Trucks, we consider our founder Kenzo Adachi's words "To provide the trucks the world needs today" as the cornerstone of our business.

For that, we seek not only to understand current customer and societal needs but also to foresee those of the future, and hence continue offering products and services that always meet needs. We aim to improve customer satisfaction by launching high-quality products that excel in durability and reliability, adopting advanced safety technologies that respond to requirements of the society, and by supporting customers who use our products.

Securing and improvement of quality

Quality management policy

Pursuing quality in all business activities

Continuously offering high levels of satisfaction for customers through products and services with first-class quality is one of the social responsibilities of manufacturers. Under the Volvo Group's Quality Policy, which bases itself on "customer focus," UD Trucks ensures and improves quality in all business activities from R&D, production, sales, to aftermarket services.

Quality management system

Acquiring the ISO9001 certification

UD Trucks attained the ISO9001 certification, a framework of international standards on quality management systems. In FY 2002, our Manufacturing Division and, in FY 2016, our Product Development Division acquired the ISO9001 certification.

Through a PDCA cycle (Plan, Do, Check, Act), we will continually advance improvements for the further enhancement of quality.

Major activities

Product Development Division

Quality management using a group-wide common process

In the Product Development Division, in order to secure high quality in products that are developed in cross-functional projects within the Volvo Group as well, we incorporate a process that is consistent throughout the Volvo Group. We also set checkpoints at each stage of development, where we confirm achievement levels of quality related targets such as in performance, functionality, durability, or reliability. By implementing such a process, not only has quality advanced, but time used for development has been optimized as well.

Manufacturing Division

Quality improvement through UD Trucks' original quality management methods

In the Manufacturing Division, UD Trucks adopted an original control method, and in accordance to the defined process, production or quality nonconformance that occurs during deliveries of parts or production processes is checked daily in an effort to secure the intended quality levels. UD Trucks' quality management method, which pursues further levels of improvement, is incorporated in other plants of the Volvo Group.

In addition, to increase awareness for quality among employees, every November is designated as the "Quality Month," and during the month, every department reconfirms processes, status of measures implemented for past defects, and pays effort to elevate technology levels.

Aftermarket Division

Diverse initiatives for the improvement of aftermarket service quality

For our customers' peace of mind in driving our vehicles, UD Trucks strives to ensure and improve aftermarket service quality mainly by polishing the skills of our service mechanics.

Training program to improve customers' uptime

The Aftermarket Division has hosted the training program "Quality Technical Conference" every year since 2013 to share the latest product quality and technical support cases, and thus strengthen the knowledge of our mechanics. From 2016, the name has been changed to "Uptime Conference," and the conference now further focuses on the improvement of uptime in customers' vehicles.

The 2016 conference was held in December at Nagoya, and about 400 mechanics and service parts engineers from 166 dealers nationwide participated. Activities in the conference included technical explanation on themes such as engines and vehicles, lectures for mechanic leaders on management processes of quality issues, and workshops to develop teamwork among staff. Furthermore, employees from the Product Development and Manufacturing Divisions presented on work closely related to aftermarket services, and it was a significant opportunity to share knowledge and align on goals to increase customers' uptime across divisions.



Aftermarket competition events on a global level

As an effort to enhance skills of employees involved in aftermarket operations at Japanese and overseas UD Trucks dealers, technical skill contests "UD Gamba Challenge" are held. For the second event contest, held in 2016, representative teams that were selected through preliminary rounds in respective countries joined the final match that was held in November at headquarters. From Japan, 4 out of 127 teams earned berths to the final round.

At the final match, a total of 11 teams from Japan, Taiwan, Thailand, Indonesia, Singapore, and South Africa were assigned to either of the two categories, heavy-duty trucks Quon or Quester, and competed on technical skills at a venue set up like the actual field. Results were the Indonesian team in the first place, the Japanese Yokohama Customer Center in the second place, and the Thai team in the third place.

Through continuation of the contest, UD Trucks will continue efforts to offer excellent services to customers.



Efforts for service improvement in the field

In order to prevent the need for re-servicing at dealers, the Aftermarket Division makes sure that each workshop analyzes their re-servicing cases and reports key factors to the division. In doing so, when there is a critical re-servicing case, a meeting is called within the dealer to discuss corrective measures. The corrective measures are shared to dealers nationwide through the Aftermarket Division in order to prevent future occurrences of similar re-servicing.

Disclosure of information on product quality

Pursuit of prompt information disclosure

In an event of defects that may have impact on customer safety or the environment, UD Trucks exercises prompt information disclosure in accordance with the guidelines provided by the Ministry of Land, Infrastructure, Transport and Tourism of Japan.

Number of cases notified
(each year in January–December period)

	2014		2015		2016	
	UD Trucks	Volvo Trucks	UD Trucks	Volvo Trucks	UD Trucks	Volvo Trucks
Recall	5	2	4	2	4	3
Improvement measures	0	0	0	1	0	2
Services campaigns	3	0	1	1	4	6

Improvement of product safety

Safety management policy

Striving to be a leading company in safe transport solutions

Under the Volvo Group's Safety Policy, which calls to eliminate any accidents caused by our products, UD Trucks engages in continued efforts for improvement of safety. We focus on furthering our knowledge on how our customers use our trucks and evaluating potential safety issues systematically throughout the development of products and services. We also strive to provide products and services equipped with safety features that cater to customer and market needs as well as the requirements of given transport infrastructure.

Major activities

Monthly meeting on the environment and safety technologies

Confirmation of product safety through thorough information sharing

In developing our products, UD Trucks makes it a principle to respect and comply with laws and regulations in countries where we operate as well as the regional/industrial self-imposed regulations while basing the development on Volvo Group's Safety Policy

at the same time.

To pursue this principle, information on various upcoming legal matters are centrally managed on a common calendar; reports on latest information and trends are communicated every month; and relevant parties are invited to the "Environment and Safety Technologies Meeting" to share various information on Japanese and overseas legal restrictions, industrial trends, new technologies, and various other information relating to safety. Where there is a potential issue that may affect our product development, managers in sections relevant to advanced development and product strategies deliberate and decide on the courses to take for the products as necessary.

Development and use of safety technologies

Implementation of advanced safety technologies

In response to increasing societal and customer needs for safety, we engage in the development and permeation of advanced safety technologies.

In the heavy-duty truck Quon, which was launched in April 2017, several advanced safety features delivered enhancements on both active and passive safety. In addition to supporting safe driving for our customers, UD Trucks aims to secure safety for other surrounding road users at the same time.

Main safety features of all-new Quon

Active Safety—Risk prediction for driver safety

• Traffic Eye Brake (brake to reduce collision damage)

Dual monitoring with millimeter-wave radar and camera dramatically improves detection of the vehicle ahead. If the possibility of collision is detected, the driver is quickly warned. If the vehicle reaches a distance where collision is possible, brakes are applied automatically at the same time to avoid collision or reduce any damage due to collision. This was adopted ahead of scheduled reinforcement of braking requirements for collision damage reduction (AEBS01 series) in November 2019.



• LDWS (lane departure warning system)

The camera monitors the traffic lanes on both sides, and if the driver unintentionally deviates from the lane when at

speed 60 km/h or above, it warns with warning indicators and buzzers.

Basic Safety—Ensuring safe driving by reducing driver fatigue

• Disc Brakes

It provides reliable braking performance while hauling cargo even on long descents or on wet pavement.

• EBS (Electronic Brake System)

Stabilizes braking performance through the combination of disk brakes, ABS (anti-lock brake system), and ASR (anti-slip regulation).

Passive Safety—Minimizing damage

• SAFES CABIN

The highly rigid cab loaded with safety features improves collision safety for the driver. The vehicle is equipped with FUPD/RUPD (a front and rear underrun protection device) that helps reduce damage to other vehicles and their drivers.

Safe-driving seminar

Providing practical programs that suit customer needs

We host “Safe-driving seminars” to further encourage safe driving of our trucks.

In response to requests from customers, we offer programs on selected topics from among those such as “safety management in transportation,” “hazards in drunk-driving,” “blind spots of trucks,” “traffic accident case studies and preventive measures,” “risk avoidance,” and “human error,” and we combine lectures and hands-on exercises so that acquired knowledge can be applied quickly.

To maximize effectiveness of the seminars, we creatively use tools such as images taken from drive recorders mounted on vehicles involved in actual accidents and visually recreate the accident situation for our customers’ virtual experiences so that they can own the safety issues.

In 2016, a total of 3,415 people participated in 127 sessions (3,901 people through 121 sessions in 2015).

We conducted a survey after the program and asked participants for their feedback on the content, materials provided, lecturers, and time allocation to refine the program and materials.

Customer support

Basic approach to customer support

Contributing to the increase of customers’ productivity through provision of beneficial information and appropriate support

The value of UD Trucks products lies not only when customers purchase them but in how much they can contribute to productivity increase after the purchase. We aim to have our products and services effectively support customers’ businesses by continuing to offer beneficial information and appropriate support for our customers.

Major activities

Eco-driving seminar

Support in fuel efficiency and CO₂ emission reduction

Since 2007, we organize “Eco-driving seminars,” leveraging our UD Information Service (UDIS)*. The session aims to provide useful knowledge and practical skills for green driving, using in-operation trucks to learn maneuvers and speed-reduction techniques. Since UDIS can evaluate driving according to factors such as gear change or speed, drivers’ tendencies can be objectively examined, and such information can contribute to fuel-efficiency improvement.

In 2016, we held sessions in 97 locations nationwide for 1,303 participants (103 locations for 1,384 participants in 2015). The seminar is backed by survey data, which indicates a 19% improvement of fuel efficiency after the program. Thus, it supports our customers to improve fuel efficiency and cut CO₂ emissions.

* An original service by UD Trucks in which installed multi-purpose screens collect real-time information on each vehicle regarding location, fuel-efficiency, and engine or other conditions of the vehicle (oil pressure and fluid temperature, etc.). The information is analyzed and provided as reports on fuel-efficiency and operation rates.

UD Extra Mile Challenge

Contribution to improvement of truck drivers’ driving skills

So that our customers can fully utilize UD Trucks’ products and services, we host a driving competition “UD Extra Mile Challenge.” At this competition, participants acquire knowledge and technical skills by competing on how to improve driving skills, uptime, and cost reduction.

In 2016 as well, the last match of the “UD Extra Mile Challenge 2016” was held at UD Trucks headquarters in November. Four teams from Thailand, Indonesia, Malaysia, and South Africa, which passed previous preliminary matches, competed using Quester, the heavy-duty truck for growth markets, and the Malaysian team became the overall champion.

“The results this time will contribute to increase the motivation levels of our other drivers. This was a significant opportunity not only for the participating drivers but also for our entire company,” commented the winning team.

By supporting the acquirement of driving skills and knowledge through the competition, UD Trucks engages in the development of drivers with high

awareness for safe driving and motivation toward the job.



UD Road Support

Prompt recovery support for a roadside breakdown

UD Trucks launched the UD Road Support* in December 2015. In cases of unexpected breakdowns, our company provides support through our call center that operates 24 hours, 365 days a year for prompt recovery. Specially trained employees provide appropriate solutions based on precise details confirmed with customers, such as vehicle condition and location. In addition, if the situation is deemed to require mechanics, we connect with dealers closest to the location of the customers' vehicles and arrange immediate dispatch. Furthermore, we provide a comprehensive support from first contact received to completion of measures, such as notifying the customer of mechanics' estimated time of arrival or preparing reports when the servicing is completed.

With this system, while precise information is provided in a timely manner to drivers, who are under stress from the unforeseen breakdowns, mechanics can concentrate on their recovery work, and thus enables further efficiency in solving problems.

* This service requires prior registration. Please contact your local UD Trucks dealer for more information.

Customer Contact Point

Reflection of customer feedback to product improvement and business activities

We provide our customers with a toll-free customer contact point, where we respond to calls for inquiries, opinions, and requests from our customers. We have developed manuals for each possible question to facilitate prompt and smooth responses. In May 2016, we reviewed our internal processes in order to provide further prompt and appropriate support for inquiries regarding vehicle troubles.

Moreover, at UD Trucks, customer feedback collected at the customer contact point is shared to relevant departments and is reflected in product improvement and other business activities. The total number of calls we received were 5,384 and 5,930 in 2015 and 2016, respectively.

Informative magazines for our customers

Regular distribution of information on UD Trucks and topics useful for business management

UD Trucks issues the magazines "Diesel News" and "Roads" for our customers. "Diesel News" covers information on expert subjects or topics useful for customers' business management, such as talent education, labor management, and case studies on competitors' best practices. From a global standpoint, "Roads" introduces activities by UD Trucks and voices of overseas customers.

Volvo Trucks also publishes its magazine "På väg" ("On the Road" in Swedish), which shares the secrets in product development from Sweden, worldwide cases of product usage, and product and service information for our Japanese customers.



Diesel News



Roads

Better Collaborative Relationships with Business Partners



Suppliers and private dealers are invaluable partners indispensable for our business. We strive to develop and enhance our relationships with them, respecting the Volvo Group policies and customer satisfaction.

Basic approach to our suppliers

Purchasing as part of CSR execution process

Providing not only raw materials and facilities but also services and consumables necessary in daily work, our suppliers play an important role in UD Trucks' business activities. To develop appropriate relationships with suppliers worldwide, we carry out purchasing activities in a manner that is compliant to the Volvo Group's purchasing policies.

Recognizing purchasing activities as part of our CSR processes, the Volvo Group engages in "responsible purchasing" through improvement of ethical awareness in supply chain and management of risks and aims to contribute to realizing a sustainable society. Therefore, we ask our suppliers to comply with the laws of respective countries and with the "Volvo Group Code of Conduct," to respect international agreements such as the UN Global Compact, and to acquire ISO14001 or certifications by other equivalent third parties for the reduction of environmental load.

In addition, the Volvo Group requests all Tier 1 suppliers to engage in equivalent practices and promulgate the purchasing policy to Tier 2 and Tier 3 suppliers through them.

Major activities

New CSR questionnaire for suppliers

Leveraging evaluation results in all departments involved in purchasing

In November 2016, the Volvo Group implemented a new CSR questionnaire design. This version allows suppliers to answer CSR questions directly through a system. Since it was co-developed with almost all automobile manufacturers, results can be shared among the automobile industry. In comparison to the past, when suppliers had to prepare responses for each manufacturer, the burden on suppliers has been alleviated.

The Volvo Group applies this questionnaire to all suppliers, regardless of whether or not they are part of the automobile industry, and reflects results in the group's purchasing process.

Measures for issues in conflict minerals

Reinforcement of efforts as a significant global issue

Since materials that are high in demand in advanced countries, such as tin, tantalum, tungsten, and gold are mainly extracted in the African conflict zones, there is an international concern that purchasing from such regions inadvertently results in funding local armed groups and perpetuating the warfare. Volvo Group takes the conflict minerals issues seriously in its global supply-chain management and bolsters its responses to international appeal.

As a part of this effort, the Volvo Group started a pilot project in 2016 to confirm usage of conflict minerals in our company's products. As a result, no usage of conflict minerals was found in the examined engines.

Basic approach to private dealers

Partners that seek improvement in customer satisfaction

UD Trucks supplies products and services to our customers through our own dealers as well as private ones, including six companies with a total of 32 distribution sites. While respecting locally rooted business activities, we share a common goal of improving customer satisfaction. We support the acquirement of higher skills and latest knowledge by offering them the same opportunities in training or other events that we provide to our own dealers.

Major activities

Technical training

Offering opportunities to improve technical skills

We proactively support aftermarket staff members to improve their technical skills. Twenty people from private dealers participated in the skill seminar, "Uptime Conference 2016," while 12 joined us in the Volvo Group's international training event, "VISTA 2015–2016."

Allowing Employees to Perform to Their Full Potential



In order to recruit, develop, and appropriately allocate competent talents that can lead the business with a global mind-set, we design and operate an HR system that leverages diverse individual capabilities and promote efforts to support flexible working styles.

Basic approach to human resource management

Fostering “global and high-performing talents”

In order to pursue a business that does not limit its sight only to Japan, but rather embraces the global arena, UD Trucks envisions employees that are “globally minded and high performing” as ideal talents. We seek highly talented people to hire, and also make diligent efforts in developing well-structured training systems and fair and square assessment schemes.

In designing and operating these systems, we place an emphasis on the values “respect for the individual,” “pro-activeness,” “diversity and cross-functionality,” “teamwork,” “passion and accountability,” and “open dialogue.” At the same time, we pay attention to employee awareness survey results and ensure that our initiatives develop a corporate culture appropriate for UD Trucks and provide work environments where each employee can fully exert capabilities.

Major activities

Diversity and inclusion management

Promoting various activities based on our policies

Based on the Volvo Group’s “Diversity and Inclusion (D&I) Policy,” we strive to realize continuous growth through diversification of personnel and development of environments that allow individuals to perform to their fullest potential. In the annual employee awareness survey, we evaluate diversity mainly in terms of the parameters of gender, nationality, and age, while the diffusion of the inclusiveness is measured through questions such as whether individuals have a sense of involvement.

Our employees also take a proactive role in D&I promotion by planning various activities through the Diversity & Inclusiveness Community Japan (DICJ), where members are elected from different divisions,

What is diversity?

Diversity refers to the state of a group of people who have different attributes such as gender, nationality, racial background, age, sexuality, religion, political orientation, socioeconomic status, and physical abilities.

What is inclusion?

Inclusion addresses the conditions in which individuals can feel respected of their being and accepted by others. This also includes the sense of being involved and supported by others so that they are able to perform to their full abilities.

and through the female employee group, Women's Inclusive Network (WIN).

In 2016, 227 participants joined the “Diversity and Inclusiveness Leadership Training” held for all managers (57 participants in 2015). Also, during the week between September 25 and October 1, we held a “D&I Week” to raise awareness for diversity and inclusiveness. During the period, we held a contest that called to employees for photos that express diversity, lectures on people with disabilities, panel discussion events that featured differences in working among countries, and a “Fika*” as an opportunity for employees across various departments and nationalities to discuss and further mutual understanding.

* A casual gathering practiced in Sweden, where people enjoy casual dialogues over tea breaks.



Panel discussion with employees from multiple countries

Recruitment and appointments

Promotion of recruitment based on personal merits and business strategies and contributions from female employees

We conduct our recruitment activities bearing in mind individual interest, preferences and abilities as well as the company’s mid-/long-term strategies. In FY 2016, we recruited 138 new graduates and 90 mid-career talents.

We also focus on driving the advancement of female employees, and there are currently 44 female managers in various departments. Furthermore, to equally offer opportunities to employees, as a general rule, new personnel for all open positions are selected from candidates who applied through our job posting system.

Number of employees

(as of end of December for every year)

Gender	2015		2016	
	Number of employees	Ratio	Number of employees	Ratio
Female	464	7.4%	800	13.2%
Male	5,769	92.6%	5,282	86.8%
Total	6,233	100.0%	6,082	100.0%

Number of nationalities (2016): 24 countries

Ireland, USA, India, Indonesia, Australia, Canada, Switzerland, Sweden, Thailand, Germany, Turkey, Nepal, Brazil, France, Vietnam, Peru, Belgium, Malaysia, Myanmar, Mexico, South Korea, China, South Africa, and Japan

Training and education

Career development support in long-term perspectives

For the employees' career development, we include discussions on development plans between managers and employees at annual performance evaluations. Also, through the planning and reviews for our succession plan, we prepare planned talent development for mid-level to senior management.

The training is based on a combination of the Volvo Group University programs, which are globally standardized, and the local training programs, adapted to the unique business environment in Japan. In addition, we operate various focus programs such as level-specific leader training sessions and function-centered training implemented by each business division.

Evaluation and compensation

Semi-annual evaluations upon 12-month objectives

All employees set their annual objectives every year and evaluate their progress with their supervisors semi-annually. We also run a remuneration system based on personal performance on the set objectives, with considerations on the team/company performance.

Employee awareness survey

Preparing action plans based on survey results

We conduct an employee awareness survey every year with the intention of promoting better communications with employees and encouraging their active participation in the business management.

With parameters, such as an employee's sense of pride to be part of the company and levels of satisfaction with the company, we measure their willingness to

participate in terms of the corporate values, objectives, and strategies. For the aspects with low scores, we prepare action plans and pursue improvement.

Work-life balance

Striving toward practical systems

So that our employees can efficiently manage both work and their personal lives, we have developed various systems and policies to support a fulfilling work-life balance.

Major systems and policies to support work-life balance

- Childcare leave
- Nursing care leave
- Work from home scheme (Temporary or fixed-period work from home)
- Flex-time system without core hours
- Policies on respect for the individual at workplace (prevention of harassment)

Health and safety at work

Promoting a safe workplace environment

Providing employees with a safe working environment is not merely a basic corporate responsibility but an important factor for smooth operation of business. The Volvo Group focuses on "commitment and participation by everyone," "prevention and promotion approach," and "excellence in implementation and execution" as three key pillars to develop a safe work environment.

Prevention of industrial accidents at production sites

Occupational safety is among the top priorities in our manufacturing activities. Through our health and safety committee, we disseminate information on safety and health to employees, and we promote mutual cautioning among employees by holding regular meetings as opportunities to share information on cases from daily operations.

Topic

Hosting social events with employees' families and communities

In November 2016, in collaboration with the union, we hosted a social event for employees' families and the community, "Communication Autumn 2016," at the headquarters/Ageo plant. So that participants could enjoy learning about UD Trucks, various programs including tours in exhibit halls, test driving in test courses, kiosks offering snacks, and superhero shows were organized. Participating children were very curious about their parents' company, and a sense of unity among employees, families, the company, and the community could be felt during the day.



As a Member of Society



UD Trucks' business is supported by not only customers and business partners but also many other people in society. We work on our society engagement activities to fulfill our responsibility as a corporate citizen to develop a relationship of trust with society.

Basic approaches to society engagement activities

We make our business resources available to society

UD Trucks harnesses its expertise, talent, facilities and equipment, functions, and other business resources as it works on its society engagement activities. We take a close look at diverse needs and challenges that our stakeholders (e.g., local communities where our offices are located; automobile-related industries) are pressed to address, and, through activities designed to create shared value, we aim to build good relationships with them to help pave the way to sustainable society.

Major activities

Instructing technical training at automobile maintenance college

Fostering future automotive engineers

UD Trucks aspires to foster potential talent to contribute to the future automobile industry and offers support for young auto-mechanics-to-be in understanding the beauty in trucks as well as in acquiring practical knowledge in the field.

In 2011, the Tohoku Region started to offer training programs on new truck manufacturing technologies and to organize tours at truck workshop buildings for students and faculty members at automobile maintenance colleges. In doing so, the Region helps them further their knowledge about trucks and truck maintenance. In November 2016, we invited 40 students aspiring to become mechanics and faculty members at Kadan Automotive Technical College to the Sendai Customer Center in Miyagi Prefecture that had been remodeled in October. From there, we left for a tour at our new factory equipped with the latest facilities for maintenance of commercial vehicles and for



shipping out parts for them. We also offered a training session to present the structure of the heavy-duty Quon truck. Though the college curriculum includes diesel engines, it is mainly with passenger cars, and many of the students had no previous experience with truck diesel engines and components. At the lecture by our employees at the Region, the students were astonished to see how large parts and tools for trucks are and learned how the electronically controlled engine and transmission of the latest heavy-duty truck are structured and how a clutter-free work environment and the latest equipment such as automatic forklifts maintain the factory's production efficiency. The training session seemed to have changed the images they'd had of trucks and truck maintenance. They commented in the post-training questionnaire on how they had been impressed by the tidy factory with the parts and tools kept in place and how the session completely changed the image they'd had of heavy-duty vehicle maintenance.

UD Trucks will continue to offer technical training sessions and factory tours for automotive technical schools across the country.

Welcoming student visits

Offering an opportunity for high school students to think about their future careers

In February 2016, 96 second graders at Ageo High School (a prefectural school in Saitama) visited UD Trucks' headquarters for an Open Office session designed to offer them an opportunity to consider their future careers. At the session, our employees illustrated the corporate activities by the Volvo Group and UD Trucks, and our young engineers—two females and one male—presented the work they currently engaged in and what their typical working day looked like to help the young people have a detailed image of what it is like to work.

Industry-academia collaboration program with Sophia University

Our contributions to foster talent with global competence

The Volvo Group offers students a wide range of opportunities as part of its efforts to foster talent with global competence capable of working in international settings. One of such opportunities is the Academic Partner Program organized in collaboration with universities in Sweden, France, the United States, and China.

In Japan, we signed a three-year partnership

agreement with Sophia University in 2014. In this partnership, the university and UD Trucks work together to discuss and plan various projects. So far, we have conducted a 4-week internship program, where students engaged in specific tasks and we provided scholarships for research projects developed by students. We also delivered an official module on global business during the autumn semester, where our employees participated as specialist lecturers.

In 2016, we launched a global internship program that sends students to the Volvo Group's offices outside Japan for 3 months, and the participants were sent to an office in the United States. Sophia University values this partnership program designed to help foster globally competent talent. The university decided to extend the agreement for three years starting from April 2017.

Disaster recovery assistance

Recovery assistance for the areas devastated by the Kumamoto earthquakes

In April 2016, powerful earthquakes hit Kumamoto Prefecture. Two magnitude-7 quakes and numerous aftershocks rocked Kumamoto as the epicenter, not only devastating the local economy and infrastructure but also causing tremendous casualties. UD Trucks donated 5 million yen to the disaster-stricken areas through the Japanese Red Cross.

We also provided information about the locations of trucks equipped with telematics for ITS Japan through the UD Information Service (UDIS) so that the information was used to figure out transport routes for aid in the devastated region. We had begun to make trucks' location information available to relevant entities as needed in 2014 with a hope of assisting in finding transport routes for relief supplies after disasters.

Reference

- **List of actions for disaster aid by ITS Japan**
http://www.its-jp.org/katsudou2014/tabid_70/id70_1/
- **Examples of published information about transport by ITS Japan's vehicles**
The website shows examples of the latest actions for disaster aid.
<http://disaster-system.its-jp.org/map4/map/>

Workwear as a donation

Providing UD Trucks' uniform for the local government

When we decided to use a single design for our Manufacturing Division's uniform, we had an extra stock of about 5,000 sets of workwear (tops and bottoms). We

donated them to Ageo City where we are based and to Rikuzentakata City in Iwate Prefecture and Motomiya City in Fukushima Prefecture, both of which had been devastated by the Great East Japan Earthquake. Now the local government employees wear the work outfit for their daily operations. They offered us letters of gratitude for the donations that they found helpful. We plan to donate the workwear also to Saitama Prefecture and technical high schools.



We also donated the stocks of fabrics and zippers used for making the workwear to two vocational aid centers in Ageo. These aid centers are for people with disabilities who make and sell handicrafts such as bags as part of their community involvement activities. The fabrics and zippers were used for making their products.

Ageo City Marathon and Half Marathon

UD Trucks supports the success of the races as a local company

Annual Ageo City Marathon and Half Marathon are held in the fall. These are the city's major events that have been supported by residents for many years, and more than 8,000 runners participate in the races each year. The half marathon is accredited by the Japan Association of Athletics Federation and enjoys the spotlight as top-notch runners from universities regularly selected for Hakone Ekiden (relay marathon) often participate.

As a company based in Ageo, UD Trucks have sponsored the races since 2013 to support their success. Each year, we give away 1,600 originally designed neck warmers to children. 80 UD Trucks employees participated in the 29th race on November 20, 2016.





Our Environmental Management

Based on our environmental programs in line with the Volvo Group’s policy and medium-/long-term plans for environmental management/conservation, UD Trucks is dedicated to contributing toward a sustainable society through the improvement of product environmental performance and the reduction of environmental load from our business activities.

Environmental management policy

Four programs as our contributions to a sustainable society

The Volvo Group has taken environmental measures over many years in accordance with its Environmental Policy. UD Trucks also follows the policy to pursue “holistic view,” “continual improvement,” “development of technologies,” and “resource efficiency” as components of our environmental program, paving the way toward the sustainable society.

Environmental program

Holistic View

Practices to reduce impact on the environment from our products, business activities, and services with a comprehensive view on the product life cycle

Continual Improvement

Initiatives pursued by employees in their work in a dedicated, continued effort

Technical Development

Proactive and innovative research and development to meet and surpass expectations of customers and society

Resource Efficiency

Practices leading to economizing the use of natural resources and reducing waste generation

Environmental management system organization

Committed to company-wide environmental plans through “structural environmental management”

UD Trucks operates a “structural environmental management” membered by the president as the environmental chief executive officer and environmental chief managers appointed from all divisions. This formation is responsible for formulating medium-/long-term plans of environmental management and conservation across the company, and it deliberates and approves a major agenda.

Each chief manager is supported by environmental officers and a management team and pursues various activities in accordance with the ISO14001, an international standard for environmental management systems, as well as with the company environmental plan.

Environmental management system organization



Progress in obtaining ISO14001 certification

Operating the environmental management system in each division/site

UD Trucks is certified with ISO14001. Starting with the certification of the Ageo plant in FY1998, our Product Development Division and other relevant departments subsequently obtained the same certification before FY2009.

Today, our Product Development and Manufacturing Divisions operate the environmental management system as a business unit of the Volvo Group, while the headquarters and Sales and Aftermarket Division manage their own systems as one site in our diligence to meet the targets and goals specified in our environmental activity plans.



ISO14001 certification

Internal/external audits on the environmental management system

Regular evaluation of operational statuses and effectiveness

In order to ensure appropriate operation of the environmental management system, we conduct an annual internal audit based on company regulations. The internal audits are conducted by a team of qualified audit committee members who investigate and assess the operational state of the environmental management system as well as the compliance with the internal standards and relevant environmental laws and regulations.

Our environmental management system is also audited by an external organization every year. The FY2016 external examination found no major recommendations.

Impact of business activities on the environment

Pursuing effective use of resources and minimization of environmental load at all stages of the product life cycle

UD Trucks analyzes environmental loads at all stages of the product life cycle spanning from R&D and design to waste disposal and recycling, thereby offering environmentally conscious products and pursuing the effective use of resources and minimizing environmental loads.

Improvement in product environmental performance

Striving to develop technologies that enhance environmental performance

UD Trucks is dedicated to comprehensive environmental protection through the development of technologies to reduce fuel consumption and filter exhaust gases, as well as by controlling environmentally hazardous materials.

Energy saving and mitigation of global warming

Developing technologies to enhance fuel efficiency

Trucks' fuel consumption is both a significant burden on business management cost and a major cause of CO₂ emissions.

For this reason, UD Trucks considers fuel efficiency to be one of the top agenda in its environmental activities and has been delivering improvement over many years. In Japan, the Heavy-Duty Vehicle Fuel Efficiency Standards 2015 was implemented, which prescribed the targets of fuel efficiency by vehicle categories in terms of weight and so on, to be achieved by manufacturers within the fiscal year. During FY2016, more than 97% of the entire units sold satisfied the target fuel efficiency, and we have achieved our company target on the average fuel efficiency score since 2012.

In addition to the efforts in improving fuel efficiency of our vehicles, we continue the nationwide initiative of Eco-driving seminars, where we provide truck drivers with lectures and practices on green driving.

Material flow

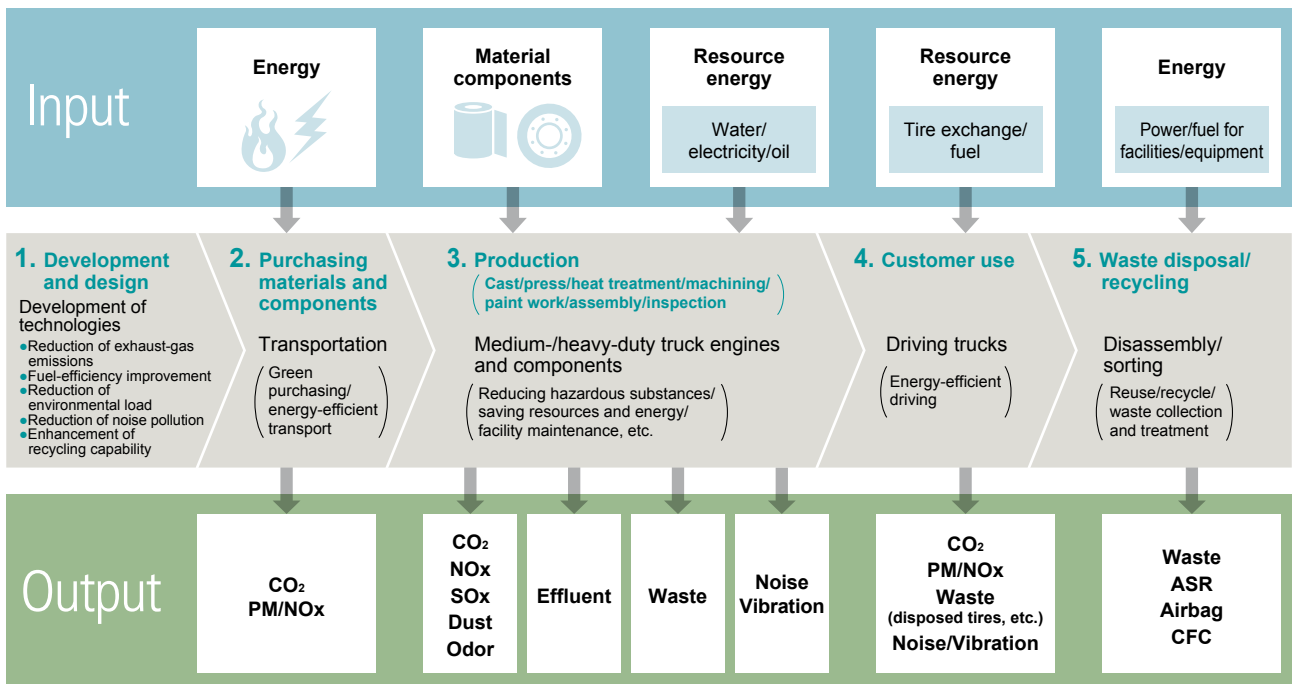

The environmental impact from trucks throughout their lifecycle is mostly attributed to the emissions of CO₂ and exhaust gases (PM, NOx) in use.

Technologies enhancing fuel efficiency

We have achieved 105% or more success in about 70% of the main models of our heavy-duty truck Quon against the target set by the Heavy-Duty Vehicle Fuel Efficiency Standards 2015. This was made possible by introducing various advanced technologies for enhancing fuel efficiency to improve powertrain performance (engine and transmission) and fine control of driving conditions.

Major technologies applied in heavy-duty trucks

Vehicle	<ul style="list-style-type: none"> Fuel Coach (as a guide for energy-efficient driving) Foretrack (a function to memorize where slopes are for anticipatory control) Reduced air resistance (e.g., an air dam integrated with the front bumper; a newly designed wind deflector)
Engine	<ul style="list-style-type: none"> Changed fuel injection system Changed piston combustion chamber shape Changed shape of the induction system Variable speed water pump
Power train system	<ul style="list-style-type: none"> ESCOT Roll (for controlled slowing down during coasting) Acceleration limiter (for controlling sudden acceleration) Soft cruise (for controlling speed)

UD Trucks' improvement on fuel efficiency

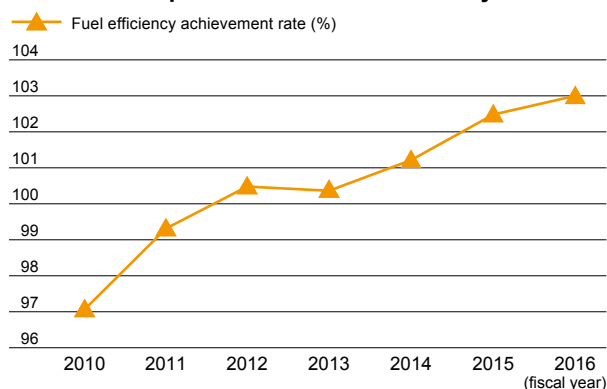

Figures are a weighted harmonic mean of net sales by units for medium-/heavy-duty trucks against 2015 figure as 100%.

Control of chemical substances

Thorough control of chemicals used in products

In compliance with laws and regulations, as well as with self-regulated industrial standards about manufacture, import, management, environmentally aware design, and recycling of chemical substances, we strive to manage the chemicals we use in our products based on the Global Automotive Declarable Substance List (GADSL).

Controlling chemical substances

Development/design phase

- Verify use of chemical substances in each process, including at suppliers
- Register data with IMDS^{*1} as necessary

Production phase

- Annual registration and reports based on the PRTR system^{*2}
- Implement as internal standards and promote substitution of hazardous substances
- Properly adapt to legal changes

^{*1} Materials database jointly managed by automobile manufacturers across the world for the purpose of environmental conservation.

^{*2} A law for managing and controlling the emissions of special designated chemical substances into the environment: Pollutant Release and Transfer Register.

Reducing environmental load in business activities

Dedicated to energy conservation, global warming prevention, and waste reduction

UD Trucks is proactive in reducing CO₂ emissions by finding energy-efficient items and horizontal rollout of good practices, waste-reduction initiatives jointly tackled with our dealers, expanding green zones in the industrial areas, and reducing environmental risk.

Energy saving and prevention of global warming

Company-wide initiative to reduce CO₂ emissions

The Volvo Group is the first automotive manufacturer who joined the WWF Climate Savers Program^{*} in 2011. The Group set its own target to reduce CO₂ emissions from the Group factories by 12% of the 2008 figure by 2014. In 2013, the Group had already exceeded the emissions-reduction target (20%).

Continuing on this result, a new target was set in 2015 to reduce further 8% on 2013 emissions by 2020, and we are boosting our activities. In an effort to align with this reduction target, UD Trucks also arranges specific action items and plans through discussions at our Energy Saving Promotion Council, which is membered by representatives of each division.

Our 2013 target was to reduce CO₂ emissions by 39% from 1990, and we achieved the target by a large

margin at 60.7%. We will continue our diligent efforts in the reduction to achieve the goal in 2020, accounting for the emissions due to future growth in production.

* A program for reducing the greenhouse gas emissions at the initiative of the WWF in partnership with world businesses.



Waste Reduction

Reducing the environmental load during waste disposal

In the product life cycle, waste generation is at its peak during the product disposal at dealers. In view of this, UD Trucks has developed its own waste-management system and introduced internal standards on waste sorting and management at all our dealers since 2014. Each dealer has installed dedicated facilities according to these standards and observes detailed waste sorting. Furthermore, we use more returnable packaging for service parts shipped to our dealers and urge them to reuse it.

In the R&D stage, we design our products keeping in mind efficient use of resources and that disassembling should be made easy. This has resulted in three-way split bumpers, easily separable headlamps with lenses and LED units that can be replaced separately, and fenders made of recycled materials.

In the production stage, we work on reducing and recycling wastes in order to minimize the final volume of waste disposal. In FY2016, we cut the final volume of waste disposal by 99.8% compared to FY1990. We also keep our recycling rate over 99% (zero emission) across the company.

UD Trucks signed a consulting agreement with a waste treatment company in April 2015 to enhance its waste management system. We ensure compliance pertinent to waste management by selecting highly reliable companies for our waste disposal, delivering required notifications to the government, managing business forms (manifestos), aggregating the volume of waste disposal, and taking other relevant actions.

Expansion of green areas

Green zone reclaimed on the site of the old headquarters building

When the construction of the headquarters building was complete in 2015, the old building was pulled down to convert the area into a green zone. We plan to continue demolishing other old buildings to expand our green zones.

Environmental risk reduction

Efforts to protect the living environment for residents near the plant

In 2016, the Ageo Plant renewed the fences around the vehicle test course on its premises. The renewed fences are higher than the old ones to reduce noise and prevent fallen leaves from being blown into the neighboring residential areas.

We also did improvement work on the retention basin on the east side of the plant as a countermeasure against sudden torrential rain that has become a common occurrence over the past years. Now the basin's capacity is about twice as large, effectively preventing floods.

Topic

UD Trucks hosts 2016 Environmental Communication

On November 5, 2016, UD Trucks received the mayors of 11 wards in the vicinity of its headquarters and plant and 4 city employees in the Environment and Economy Department for the 2016 Environmental Communication.

At the meeting, after the opening speech, our representative presented UD Trucks' corporate history and the summary of the company's current business. Then, the manager responsible for the environmental policy reported what we do for the environment and our CSR activities for the local community. After the presentations, we took the group for a test ride on the test course and on a tour of the exhibition hall. We also had a chance to exchange views and opinions.

The participants provided positive feedback, such as that it was a great opportunity for them to learn about UD Trucks and its diverse efforts and that now they have a clear picture of what UD Trucks strives to do for the environment and the local community. They also requested that the company continue and expand these efforts to further develop positive relations with the community.



Energy/CO₂-related data (Ageo Plant, Hanyu Plant, Gunma Parts Distribution Center)

The total amount of CO₂ emission/basic unit

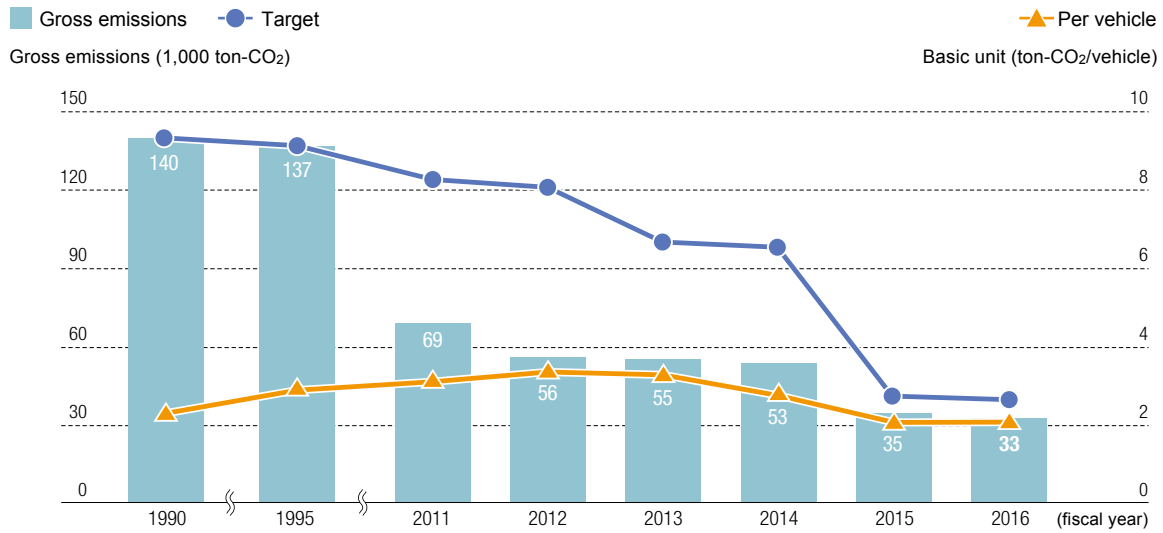

CO₂ emissions by energy source

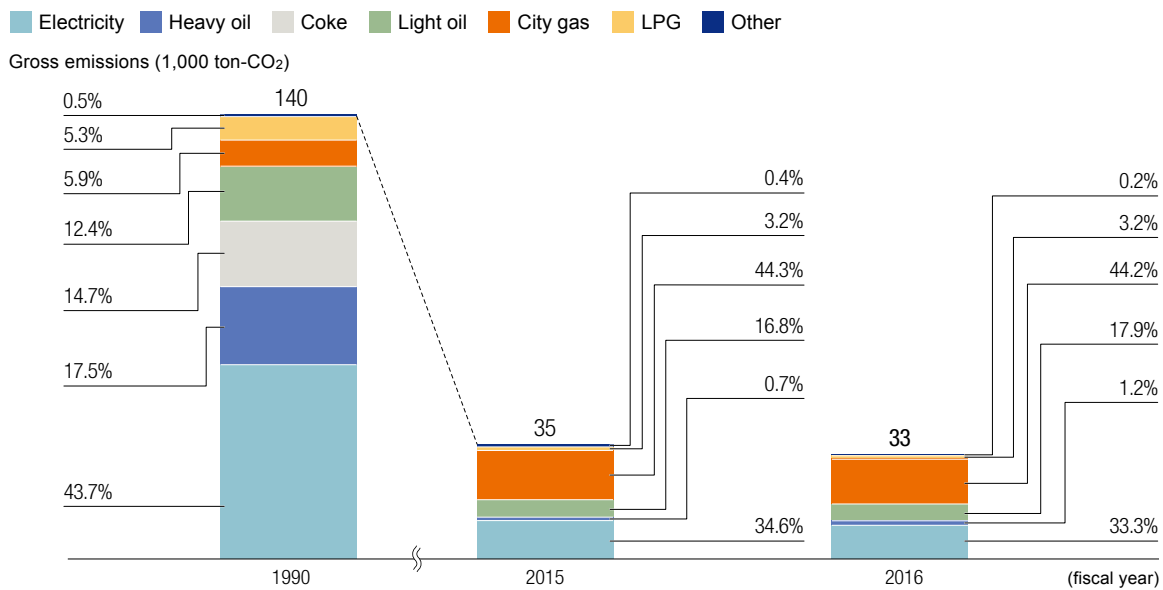

Heat budget of large-scale natural gas cogeneration

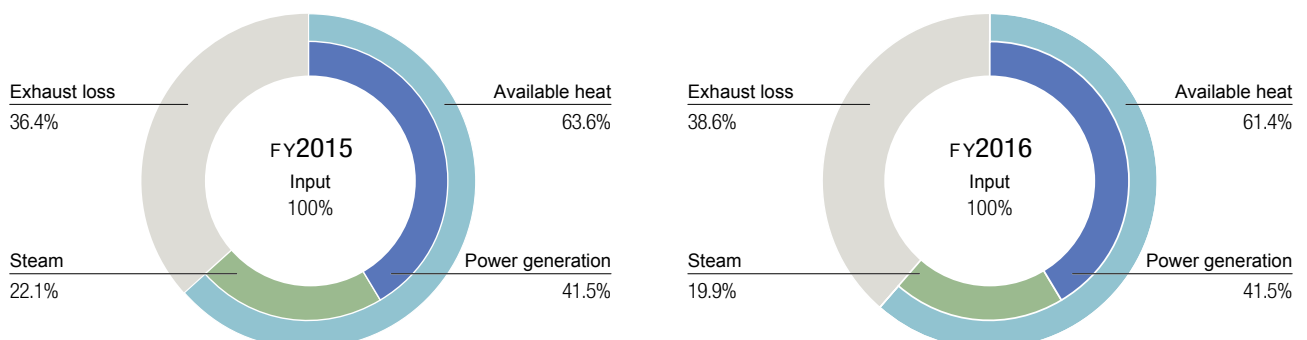

Resource-related data (Ageo Plant, Hanyu Plant, Gunma Parts Distribution Center)

Overview of waste disposal (FYs2015 and 2016)

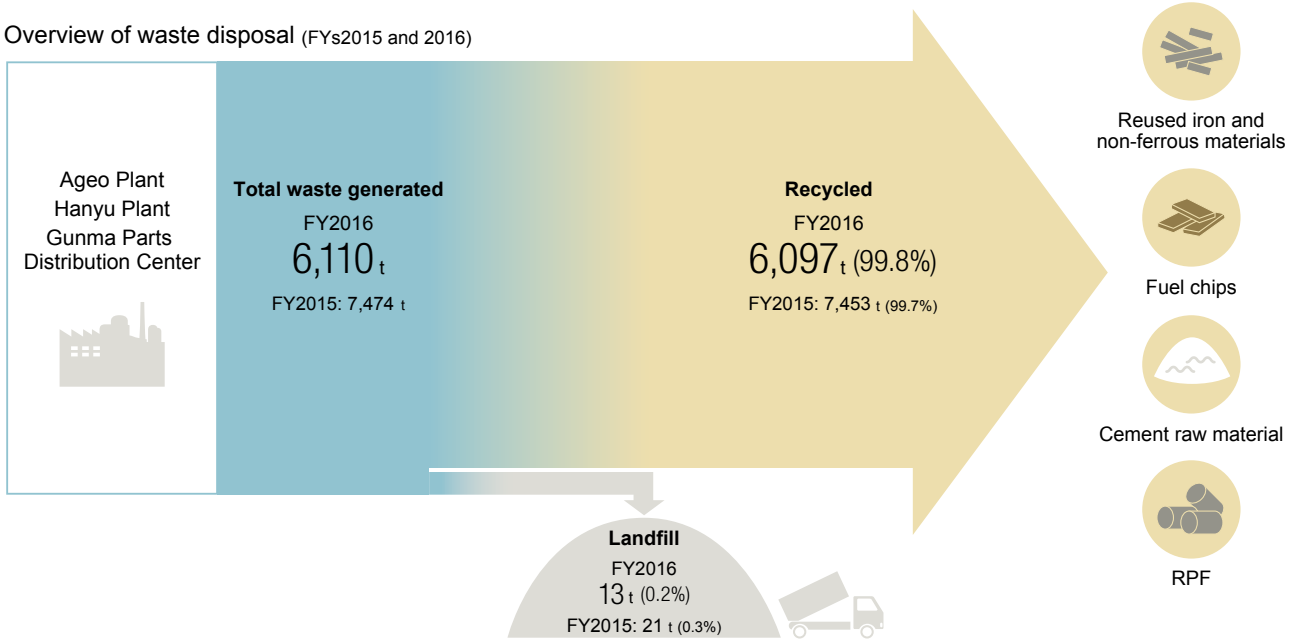

Final waste disposal volume (landfill)/recycling rate

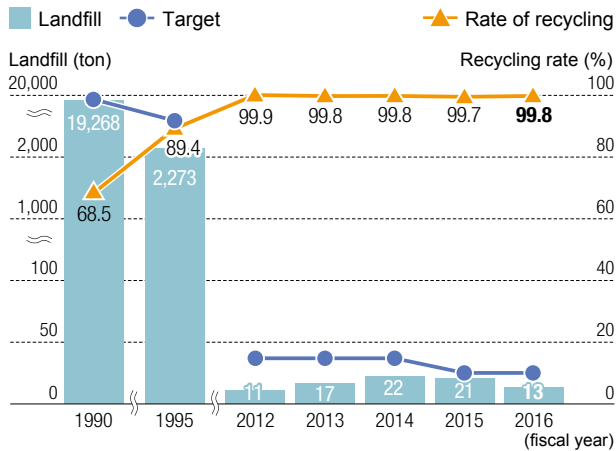

The target figures underwent review from 2004 based on the initiatives conducted by the Japan Automobile Manufacturers Association's Recycling and Waste Reduction Subcommittee.

Water consumption/basic unit

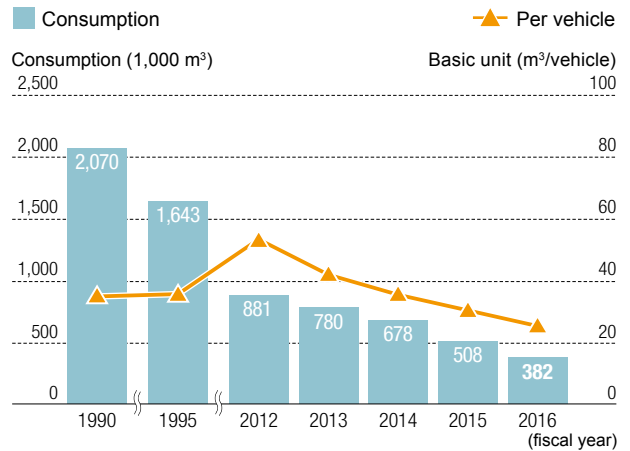

PRTR data

Ageo Plant (FY2016)

Unit: kg/year (mg-TEQ/year for dioxin and other chemical compounds)

Class	Ordinance number	Chemical substance	Volume handled	Emissions					Recycled	Consumption (products)
				Atmosphere	Water	Soil	Mileage Waste	Removal treatment		
Class 1 designated chemical substances	1	Water-soluble zinc compound	1,065	0	11	0	0	309	0	746
	53	Ethylbenzene	23,502	10,907	0	0	0	2,389	10,080	126
	80	Xylene	42,695	15,887	0	0	0	2,605	23,519	683
	296	1,2,4-Trimethylbenzene	2,900	1,378	0	0	0	660	0	863
	297	1,3,5-Trimethylbenzene	5,104	596	0	0	0	53	4,293	161
	300	Toluene	9,571	6,562	0	0	0	1,699	186	1,124
	438	Methylnaphthalene	519	9	0	0	0	0	0	510

Environmental data of environmental facilities in FY2016

(Environment Data Measurement Period: From April 2016 to March 2017)

Ageo Plant

Water quality	Measured item	Unit	Regulation designation	Max.	Min.	Average
BOD: Biochemical Oxygen Demand COD: Chemical Oxygen Demand SS: Suspended Substance ND: Not Detected Figures within parentheses () show average per day	Discharged volume	m ³ /day	—	9,573	0	1,117
	pH	—	5.8–8.6	7.7	6.7	7.4
	BOD	mg/ℓ	25 (20)	3.3	1.1	2.2
	COD	mg/ℓ	160 (120)	8.8	3.4	5.4
	SS	mg/ℓ	60 (50)	ND	ND	ND
	N-Hex (mineral oil)	mg/ℓ	5	ND	ND	ND
	Phosphorus	mg/ℓ	8	ND	ND	ND
	Nitrogen	mg/ℓ	60	7.4	1.3	2.9
	Zinc	mg/ℓ	2	ND	ND	ND
Fluorine and compound	mg/ℓ	8	ND	ND	ND	

Atmosphere	Facility	Measured item	Unit	Regulation designation	Max.	Min.	Average
NOx: Nitrogen oxide	Water boiler	NOx	ppm	150	56	46	51
	Cogeneration (gas engine)	NOx	ppm	200	110	100	105
	Dry furnace 1	NOx	ppm	230	33	10	21.5
		Dust	g/m ³ N	0.2	ND	ND	ND

Hanyu Plant

Water quality	Measured item	Unit	Regulation designation	Max.	Min.	Average
BOD: Biochemical Oxygen Demand COD: Chemical Oxygen Demand SS: Suspended Substance ND: Not Detected Figures within parentheses () show average per day	Discharged volume	m ³ /day	—	47	0	8
	pH	—	5.8-8.6	7.5	7.0	7.2
	BOD	mg/ℓ	25 (20)	2.1	2.0	2.1
	COD	mg/ℓ	160 (120)	3.0	1.2	2.0
	SS	mg/ℓ	60 (50)	ND	ND	ND
	N-Hex (mineral oil)	mg/ℓ	5	ND	ND	ND
	Nitrogen	mg/ℓ	60	20	3.5	12.9
	Zinc	mg/ℓ	2	0.10	ND	ND

Atmosphere	Facility	Measured item	Unit	Regulation designation	Max.	Min.	Average
NOx: Nitrogen oxide	Boiler heavy oil (1.2 tons)	NOx	ppm	180	95	54	74
		SOx	m ³ N/h	0.493	0.008	0.002	0.004
		Dust	g/m ³ N	0.3	0.007	0.005	0.006
	Water cooler/heater	NOx	ppm	180	86	54	70
		SOx	m ³ N/h	0.531	0.004	0.004	0.004
		Dust	g/m ³ N	0.3	0.005	0.004	0.005

Gunma Parts Distribution Center

Water quality	Measured item	Unit	Regulation designation	Max.	Min.	Average
BOD: Biochemical Oxygen Demand SS: Suspended Substance ND: Not Detected	Discharged volume	m ³ /day	—	25	0	7.4
	pH	—	5.8–8.6	7.5	6.5	6.9
	BOD	mg/ℓ	80	6.2	2.2	4.6
	SS	mg/ℓ	20	6.0	1.0	2.8
	N-Hex (mineral oil)	mg/ℓ	1	ND	ND	ND

Atmosphere	Facility	Measured item	Unit	Regulation designation	Max.	Min.	Average
NOx: Nitrogen oxide	Boiler heavy oil Nos. 1, 2 and 3	NOx	ppm	180	74	62	68
		Dust	g/m ³ N	0.2	0.002	0.001	0.002

ISO14001 certification status

FY1998	Headquarters/Ageo Plant	
FY2002	Product Development Division	
FY2004	Kounosu Plant	*Transferred to Global Component Technologies Corporation in January 2015
FY2004	Hanyu Plant	*Transferred to UniCarriers Corporation in March 2016
FY2005	DRD Co., Ltd.	*Transferred to Tempstaff Co., Ltd. in June 2013
FY2005	Techsus Co., Ltd.	*Acquired by UD Trucks Corporation in July 2013
FY2006	N-Tech Co., Ltd.	*Transferred to Kihara Manufacturing Co., Ltd. in March 2015
FY2008	Japan Vehicle Co., Ltd.	*Acquired by UD Trucks Corporation in July 2011
FY2009	Volvo Logistics Corporation Japan Co., Ltd. *Acquired by UD Trucks Corporation in April 2014	

PCB storage status (FY2016)

	Ageo Plant
Reactor	1,000 kg
Discharge coil	40 kg
Condenser	6,019 kg
Stabilizer	11,400 kg
Transmitter*	14,638 kg
Breaker	220 kg
Contaminated materials (waste clothes, etc.)	10 kg
Total	33,327 kg

*Including the weight of the transmitter main body.

The Volvo Group

UD Trucks belongs to the Volvo Group, which is one of the world's leading manufacturers of trucks, buses, construction equipment and marine and industrial engines. The Group also provides complete solutions for financing and service. The Volvo Group, with its headquarters in Gothenburg, Sweden, employs about 95,000 people, has production facilities in 18 countries and sells its products in more than 190 markets.

Strong positions globally

The Volvo Group's products and services are designed to help improve society's functionality. Since many of the Volvo Group's customers are in the transport or infrastructure industry, the Group places a high priority on products' reliability and productivity, thereby offering products and services that contribute to the success of its customers' businesses.

The Volvo Group's competitive products and service

network coupled with a wide range of products (e.g., financial instruments, insurance policies, and leases) have placed the Group in a leading position across the markets worldwide. In 2016, the Group was ranked 2nd in the world for the sales of heavy-duty trucks, 3rd for those of construction equipment, 2nd for heavy-duty diesel engines, 1st for diesel engines for leisure boats, and 2nd for buses in the target segments and markets.



Key performance 2016

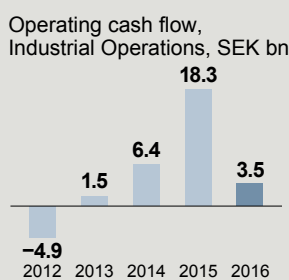
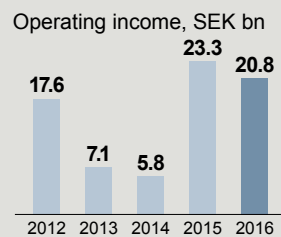
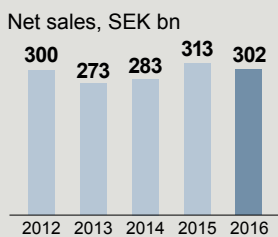

SEK: Swedish krona

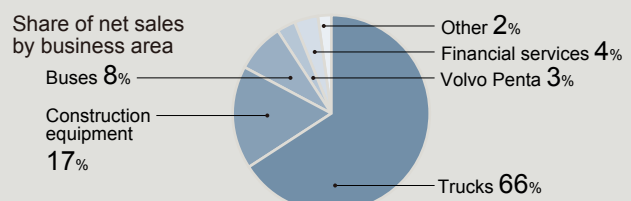
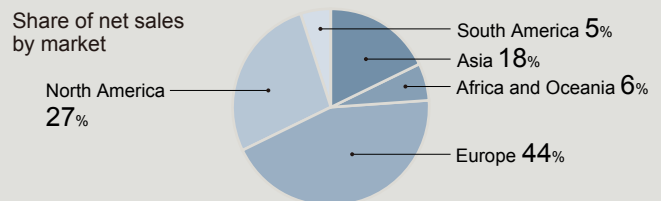
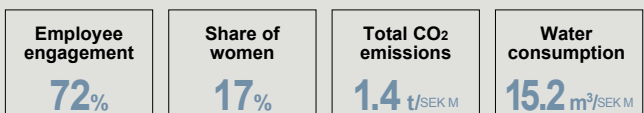

Corporate strategy

In 2016, the Volvo Group announced the following: The Group's new Mission, the Vision needed to fulfill the Mission, Aspirations that underpin the effort toward the Vision, and Values around which the Group's corporate culture will develop. Shared by all employees and reflected in all business activities, they are meant to point the Volvo Group toward the right direction as it works toward further development of its businesses that aim to help pave a way to sustainable society.

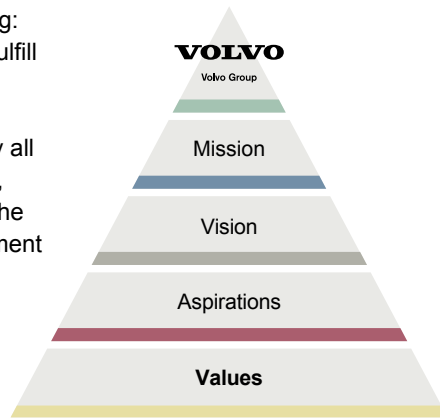

- Driving prosperity through transport solutions
- Be the most desired and successful transport solution provider in the World
- Have leading customer satisfaction for all brands in their segments
- Be the most admired employer in our industry
- Have industry leading profitability
- Customer success
- Trust
- Change
- Performance
- Passion

Strong brands

The Volvo Group operates multiple brands, including Volvo (trucks, construction equipment, buses), Volvo Penta, UD Trucks, Terex Trucks, Renault Trucks, Prevost, Nova Bus, and Mack Trucks. It also has partnerships with SDLG, Eicher, and Dongfeng Commercial Vehicles for joint ventures.

By offering diverse products and services from these brands, the Volvo Group meets different needs of customers in both mature and growth markets.



Regular employees 2016

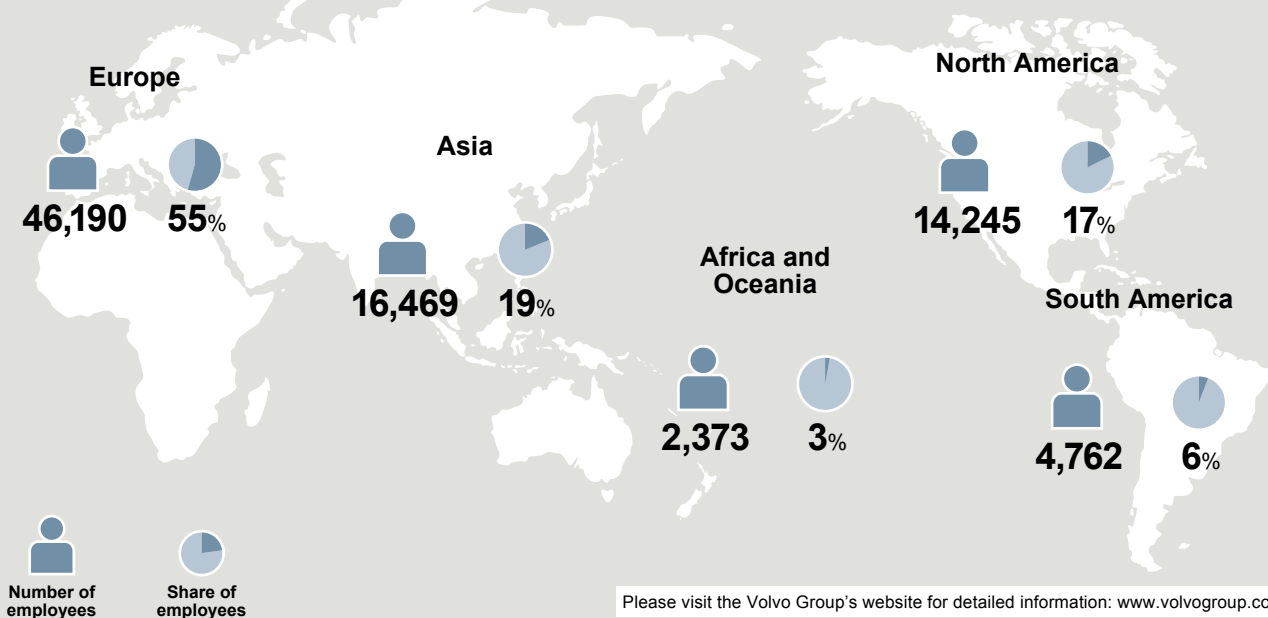

Please visit the Volvo Group's website for detailed information: www.volvogroup.com

UD Trucks Corporation

1-1, Ageo-shi, Saitama 362-8523, Japan
udtrucks.com